

# Vista Explodida do Produto

---

Motivo	Lançamento
Modelos de Produto	BFO4VBRNNA
Categoria do Produto	Cocção
MARcas do Produto	Brastemp
Foto da Peça	Itens com foto aparecerá o símbolo amarelo  118

Em caso de dúvida entre em contato com o CDP Códigos através de uma Solicitação de Serviços no CRM



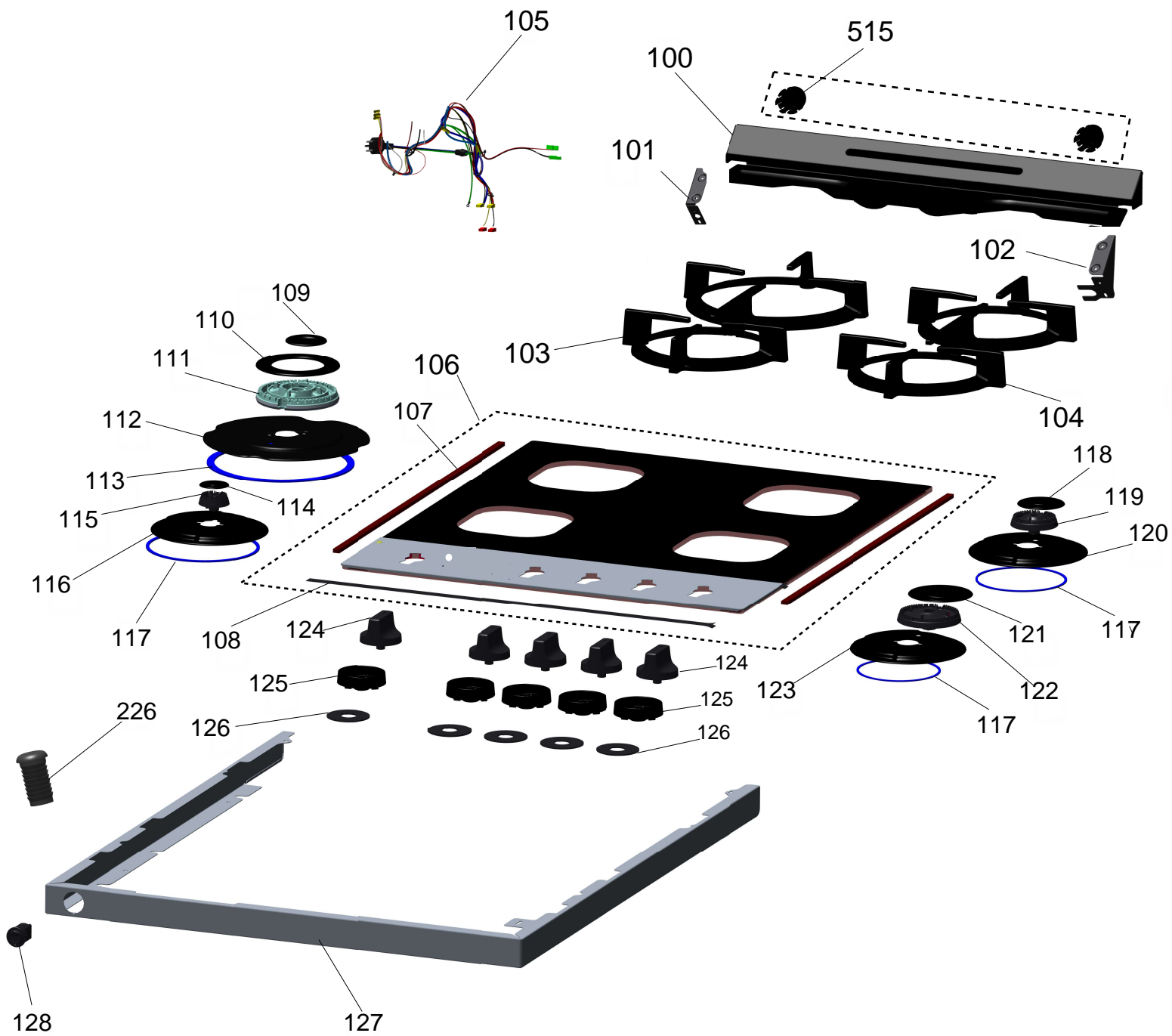

Ref	Código	Descrição	Qtde Aplicada
105	W11407010	REDE ELETRICA PRINCIPAL GRILL + TIMER	1
105	W11527815	REDE ELÉTRICA ESPECIAL AC	1

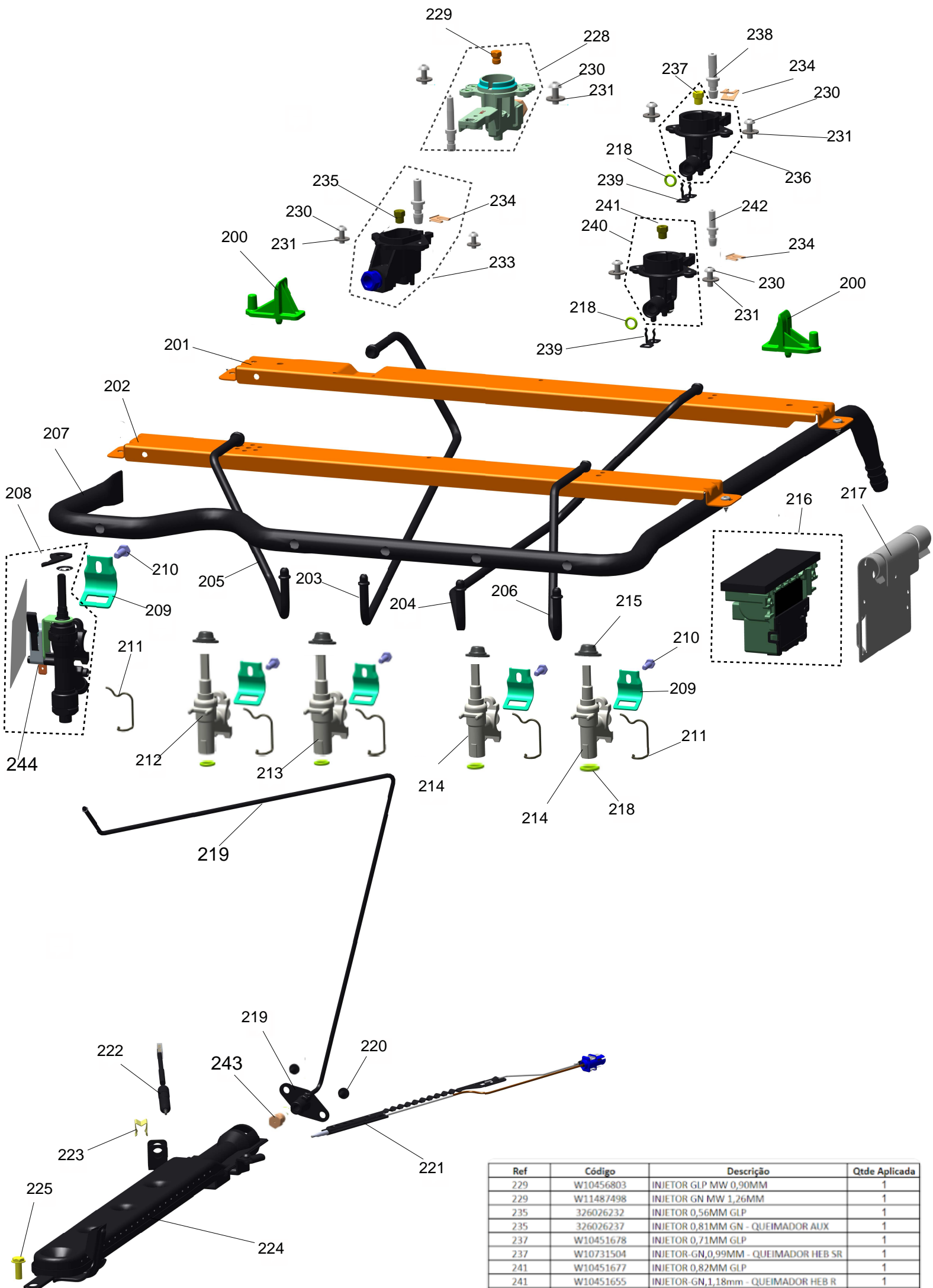

Ref	Código	Descrição	Qtde Aplicada
229	W10456803	INJETOR GLP MW 0,90MM	1
229	W11487498	INJETOR GN MW 1,26MM	1
235	326026232	INJETOR 0,56MM GLP	1
235	326026237	INJETOR 0,81MM GN - QUEIMADOR AUX	1
237	W10451678	INJETOR 0,71MM GLP	1
237	W10731504	INJETOR-GN,0,99MM - QUEIMADOR HEB SR	1
241	W10451677	INJETOR 0,82MM GLP	1
241	W10451655	INJETOR-GN,1,18mm - QUEIMADOR HEB R	1
243	W10489388	INJETOR 0,85 MM GLP - FORNO	1
243	W10489390	INJETOR 1,20MM GN - FORNO	1

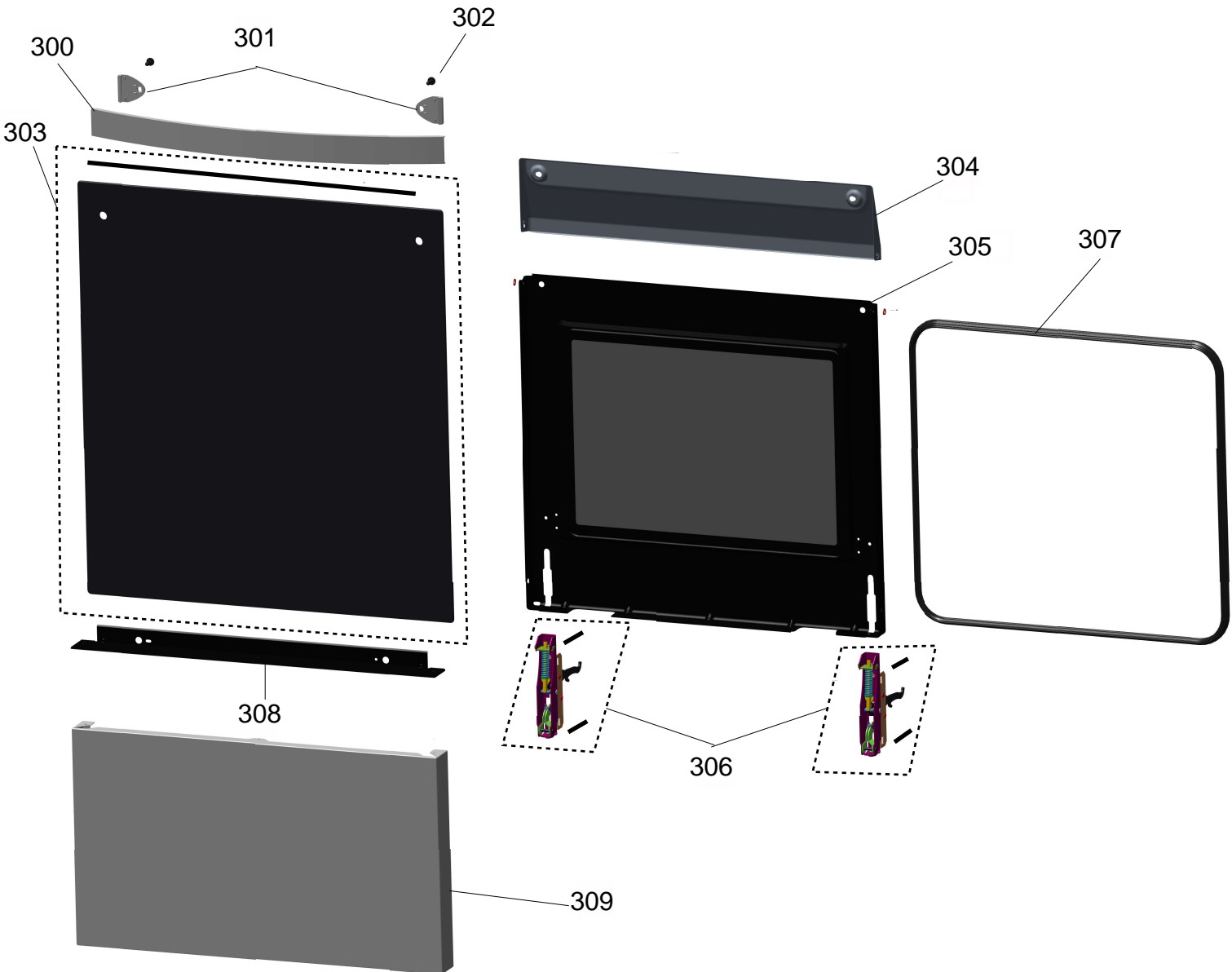

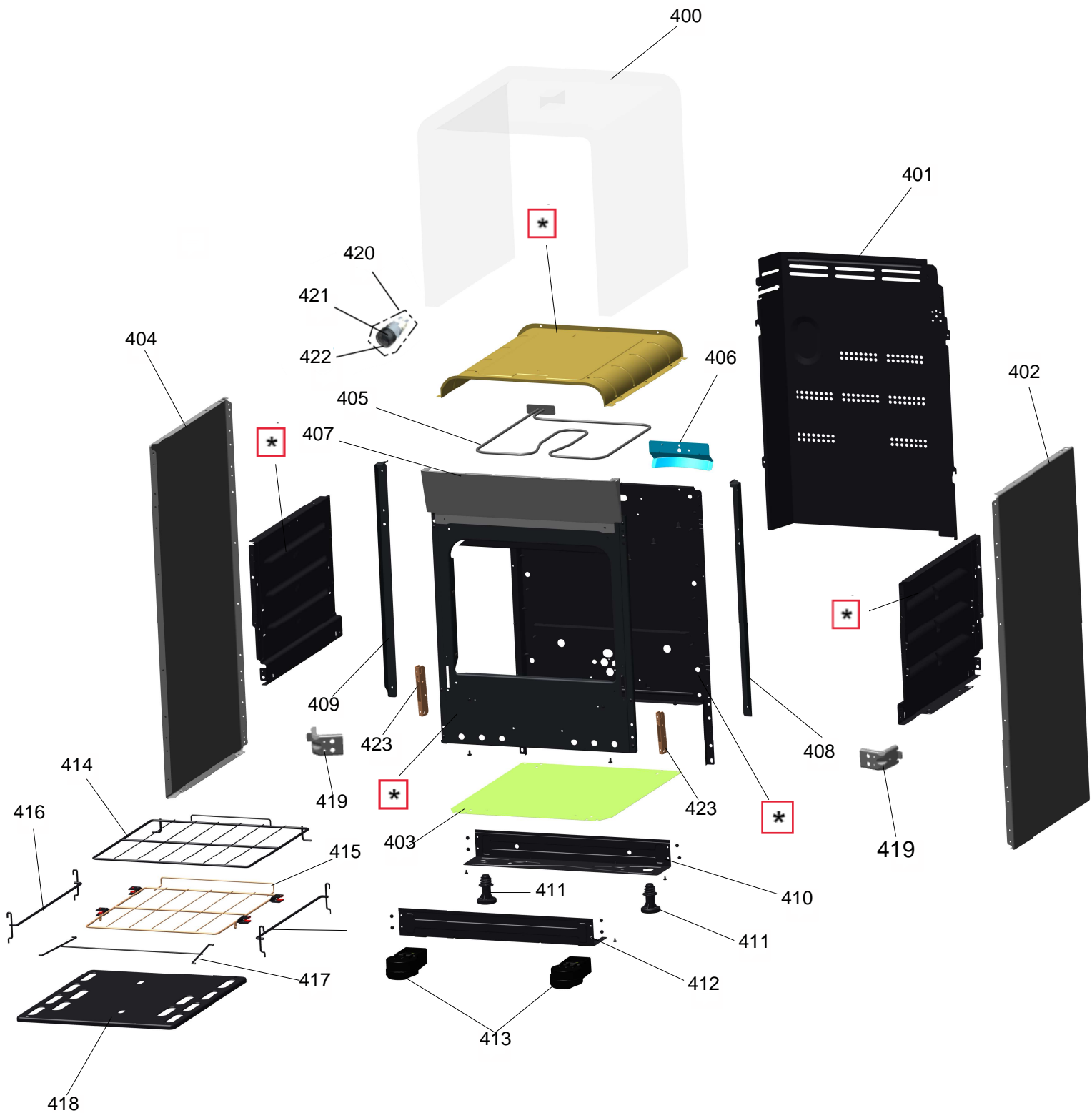

As peças indicadas com asterisco (\*) não são de reposição. Deverá ser aberto nova solicitação de serviços (via CRM) para o canal de avaliação de troca de produto, preenchendo a Categorização da Solicitação de Serviço conforme abaixo:

**Fase:** Diagnóstico/Reparo.

**Categoria 1:** Produto não tem solução técnica ou peça reposição.

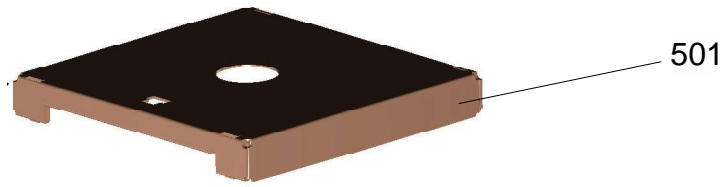

501

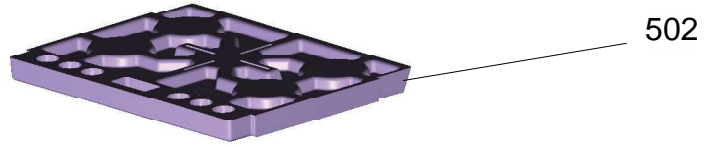

502

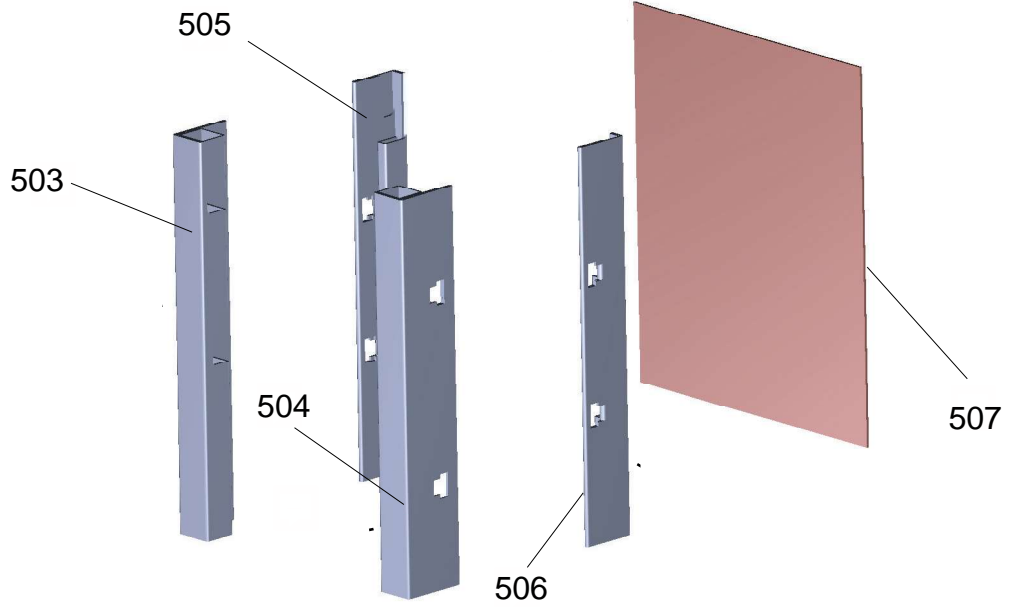

505

503

504

506

507

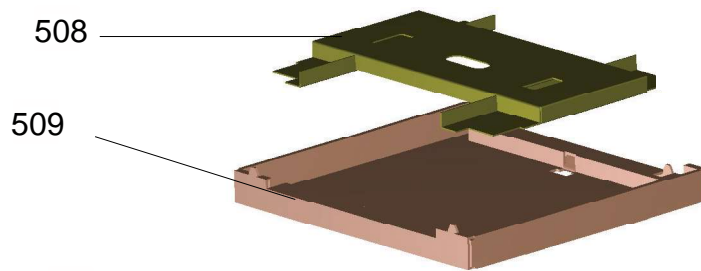

508

509

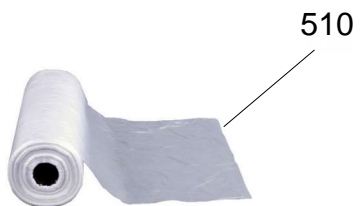

510

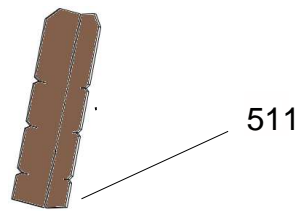

511

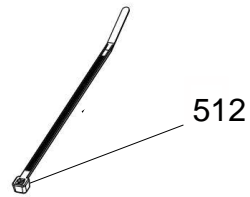

512

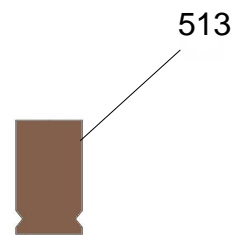

513

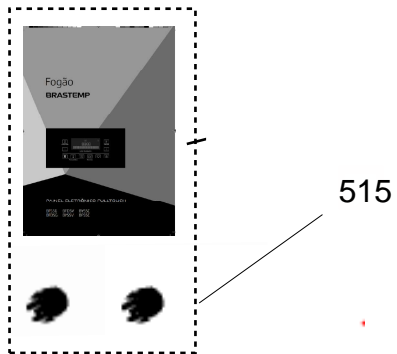

515

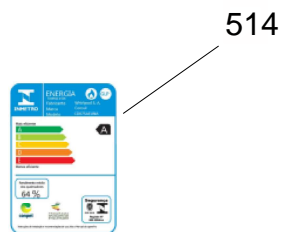

514

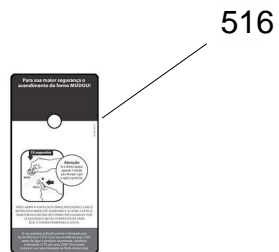

516

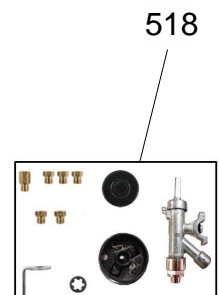

518