

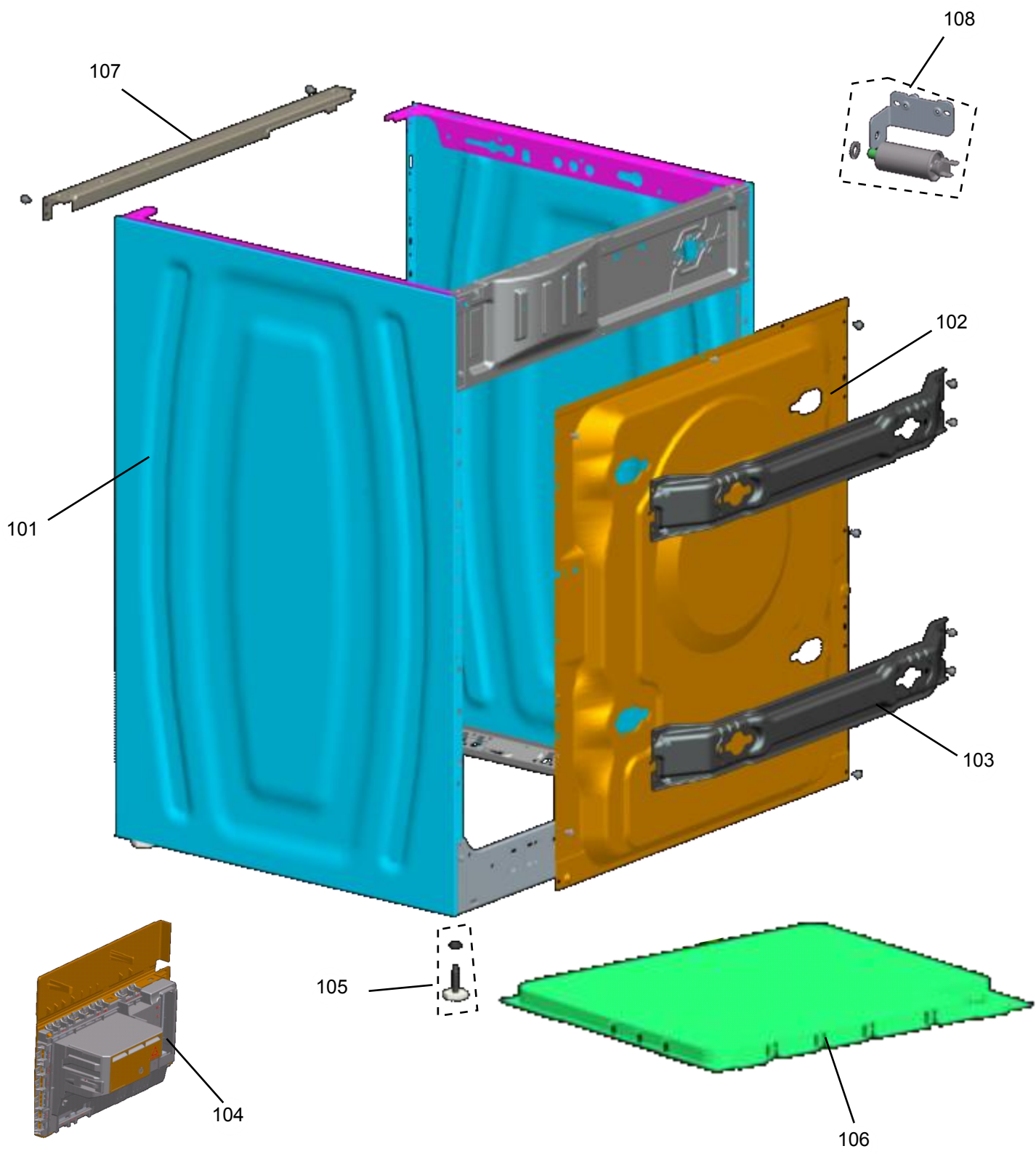



BRASTEMP

CATÁLOGO DE PEÇAS

BNS10AE

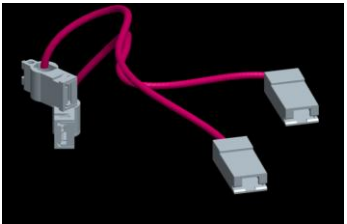
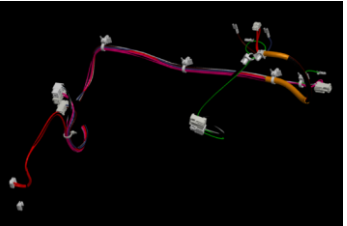
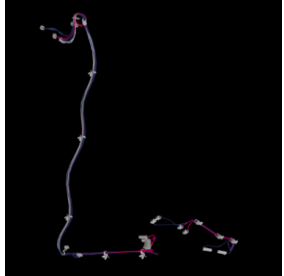
Revisão	Motivo	Páginas Alteradas	Elaborado Por	Revisado Por	Data
R0.0	Lançamento		André Lemos Silva		11/11/13

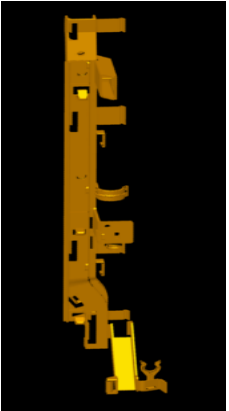
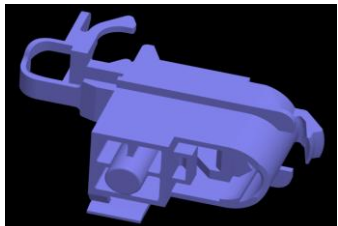
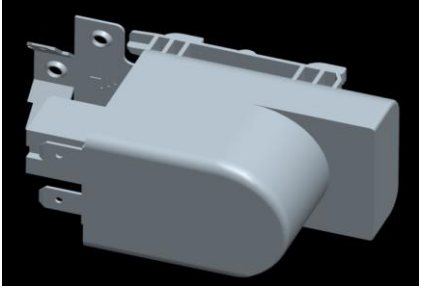
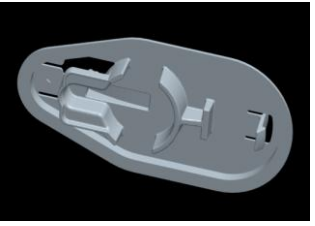

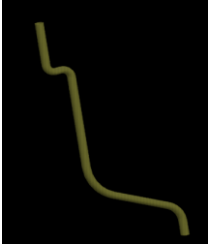
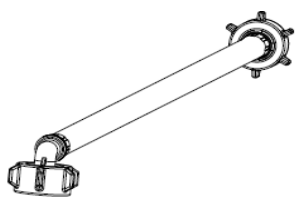

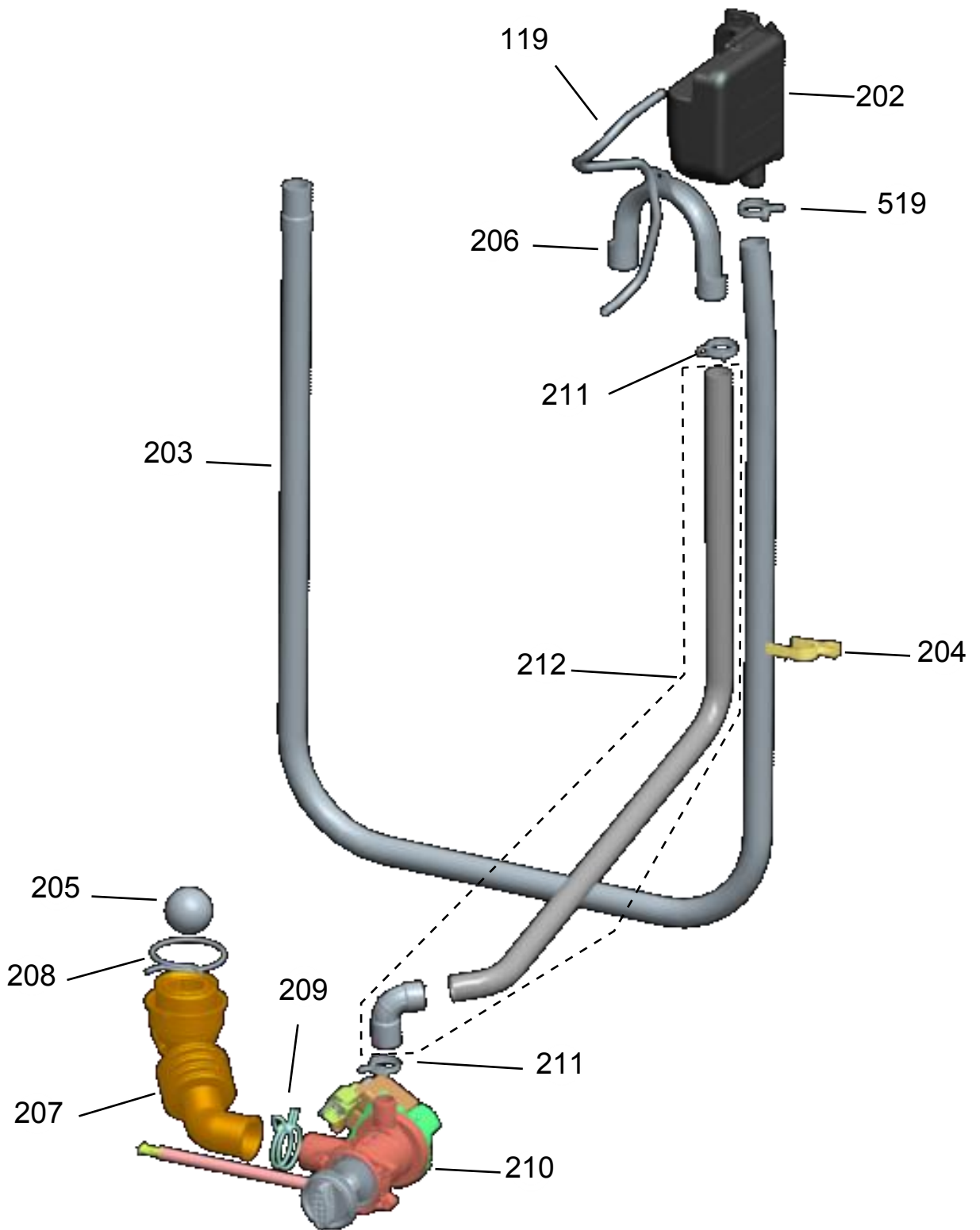

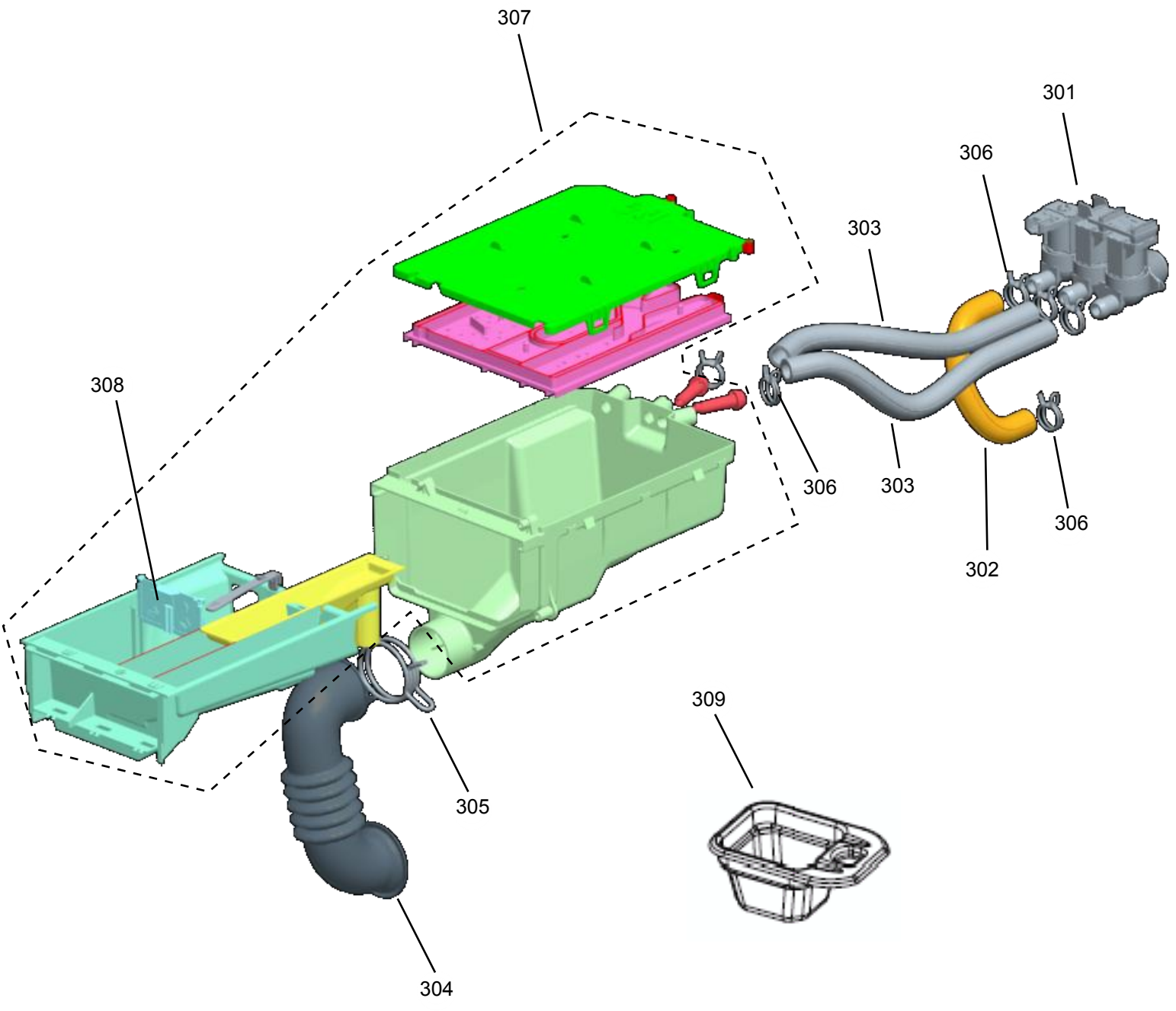
Desenho	Descrição	Código	Referência
	REDE ELETRICA (RESISTENCIA SECAGEM)	W10557137	109
	Rede Eletrica (motor ,filtro)	W10490898	110
	Rede Eletrica (termostatos/ventoinha)	W10475058	111
	Rede Eletrica (bomba de drenagem,interface))	W10475056	112
	CANALETA REDE ELETRICA FRONTAL	W10532879	113
	PRENSA CABOS (W10451343)	W10620890	114
	FILTRO ENTRADA 127V	W10529783	115
	FILTRO ENTRADA 220V	W10567212	
	TAMPA, ORIFICIO TRANSPROTE	W10387622	116
	CJ PARAFUSO DE TRANSPORTE	W10549125	117
	PRESSOSTATO	W10517299	118
	MANGUEIRA PRESSOST 46197101666	W10616157	119
	MANGUEIRA DE ENTRADA DE AGUA	W10509021	120

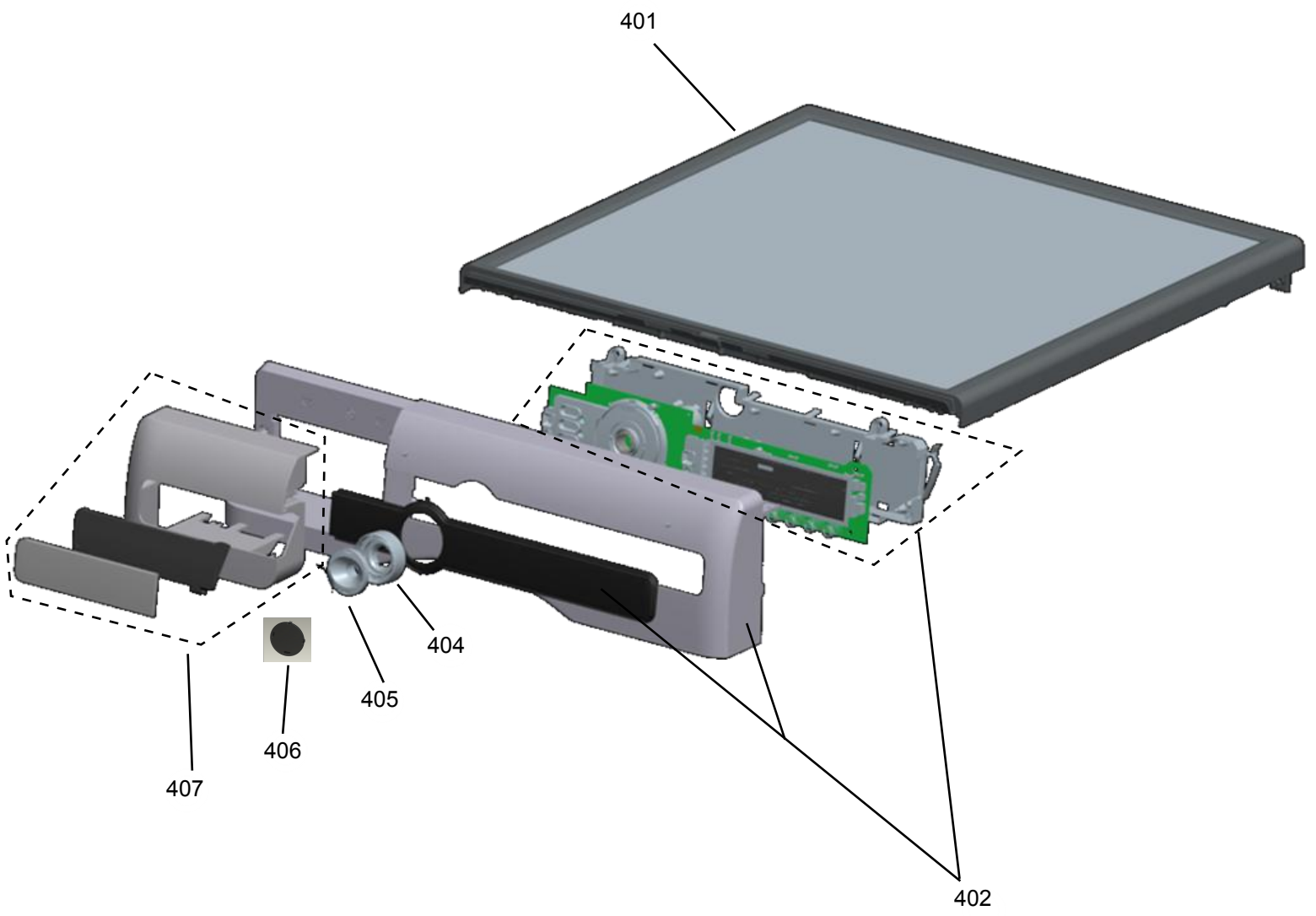

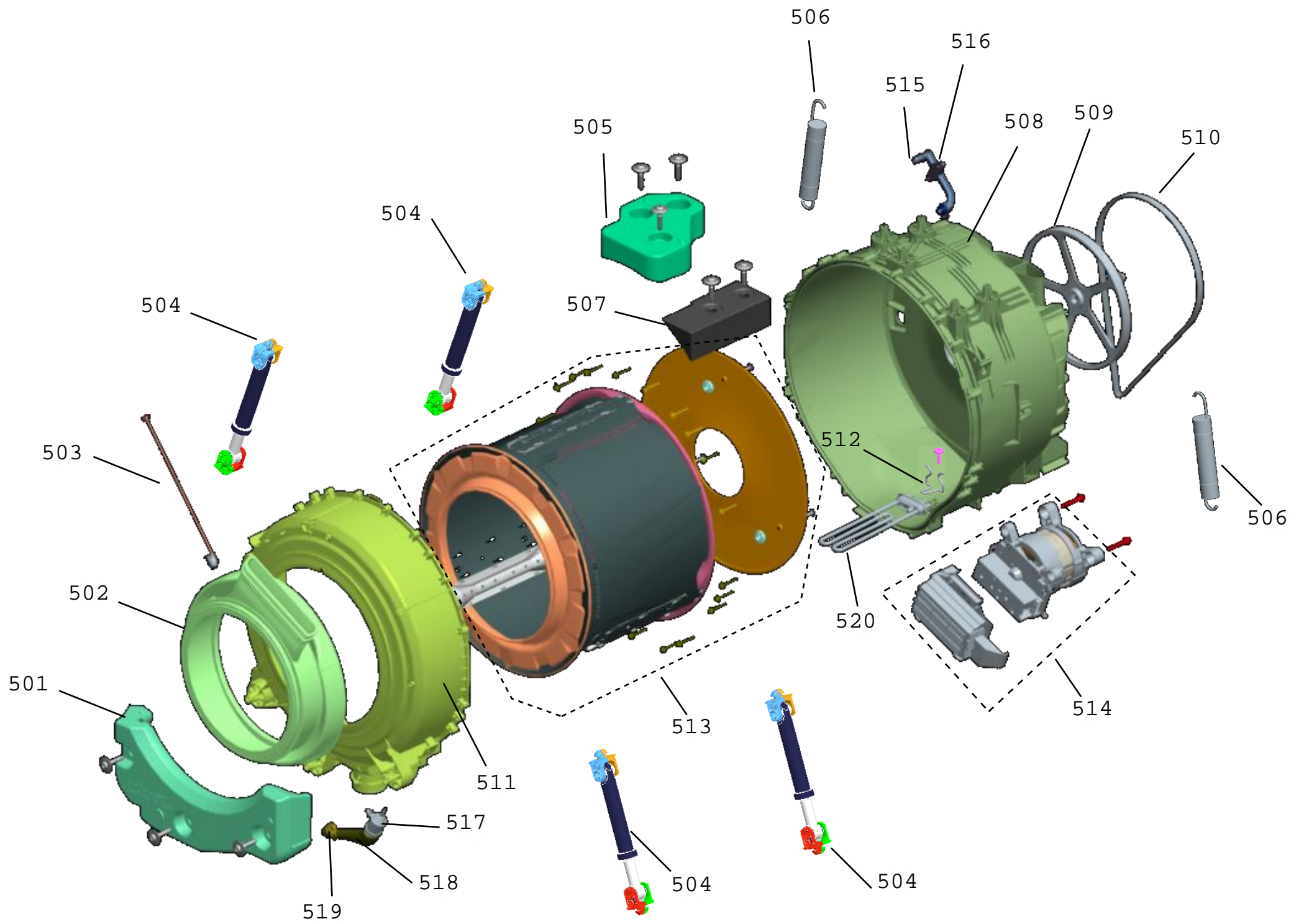

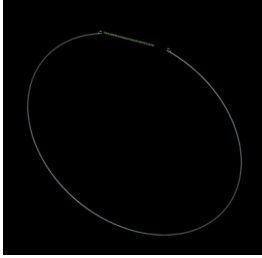
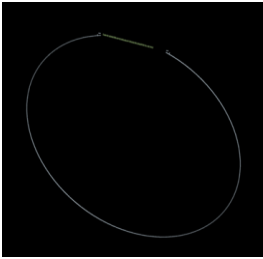

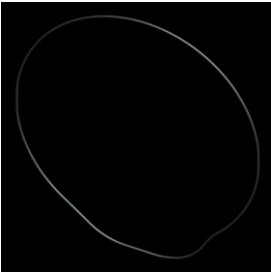

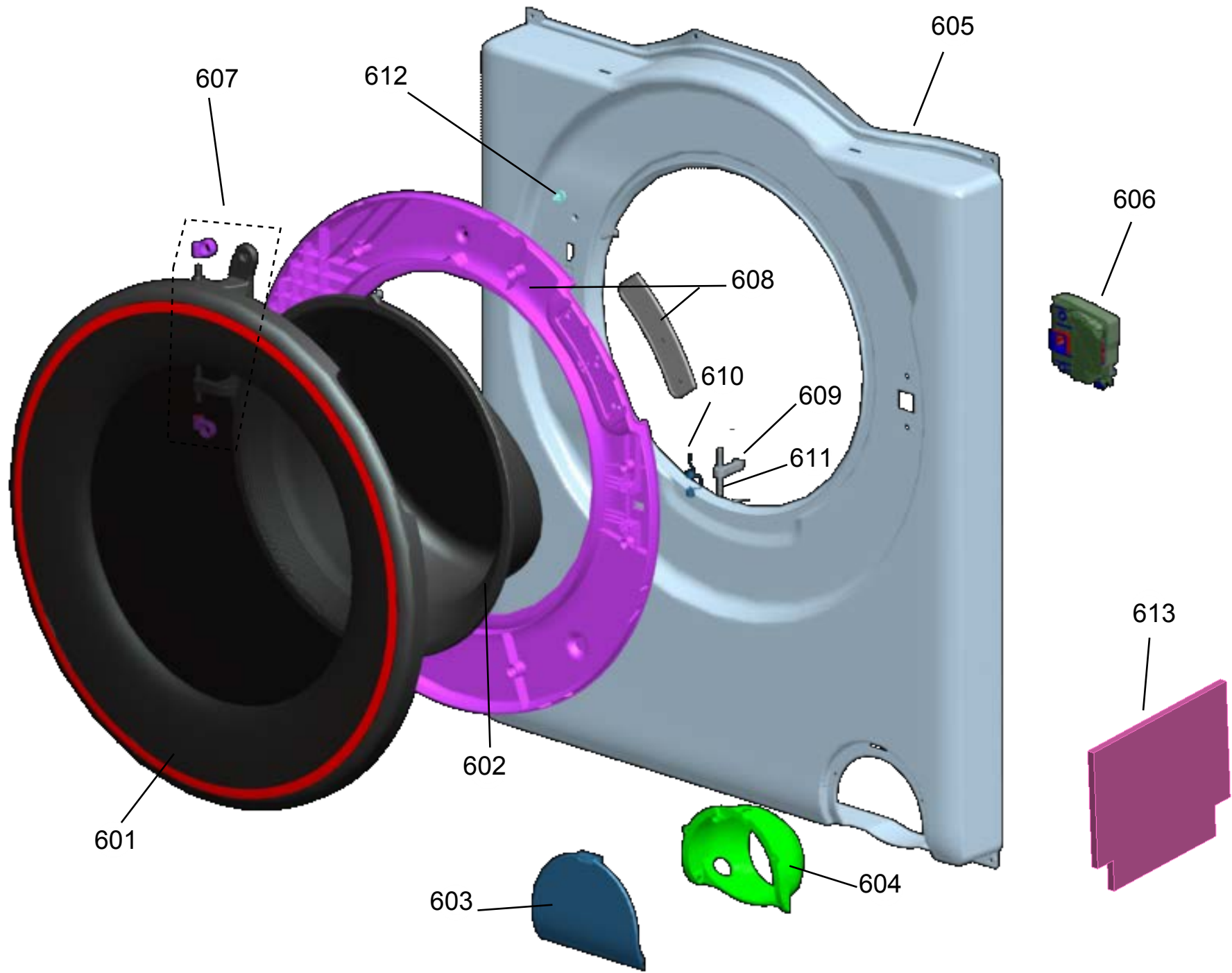

Desenho	Descrição	Código	Referencia
	<p>RETENTOR, GAXETA46197140882</p>	<p>W10616183</p>	<p>521</p>
	<p>RETENTOR, PAINEL 46197140883</p>	<p>W10616171</p>	<p>522</p>
	<p>REDE ATERRAMENTO CESTO Cj</p>	<p>W10448080</p>	<p>523</p>
	<p>VEDACAO, TANQUE</p>	<p>W10335772</p>	<p>524</p>
	<p>PUXADOR EMERGENCIAL, TRINCO</p>	<p>W10423290</p>	<p>525</p>

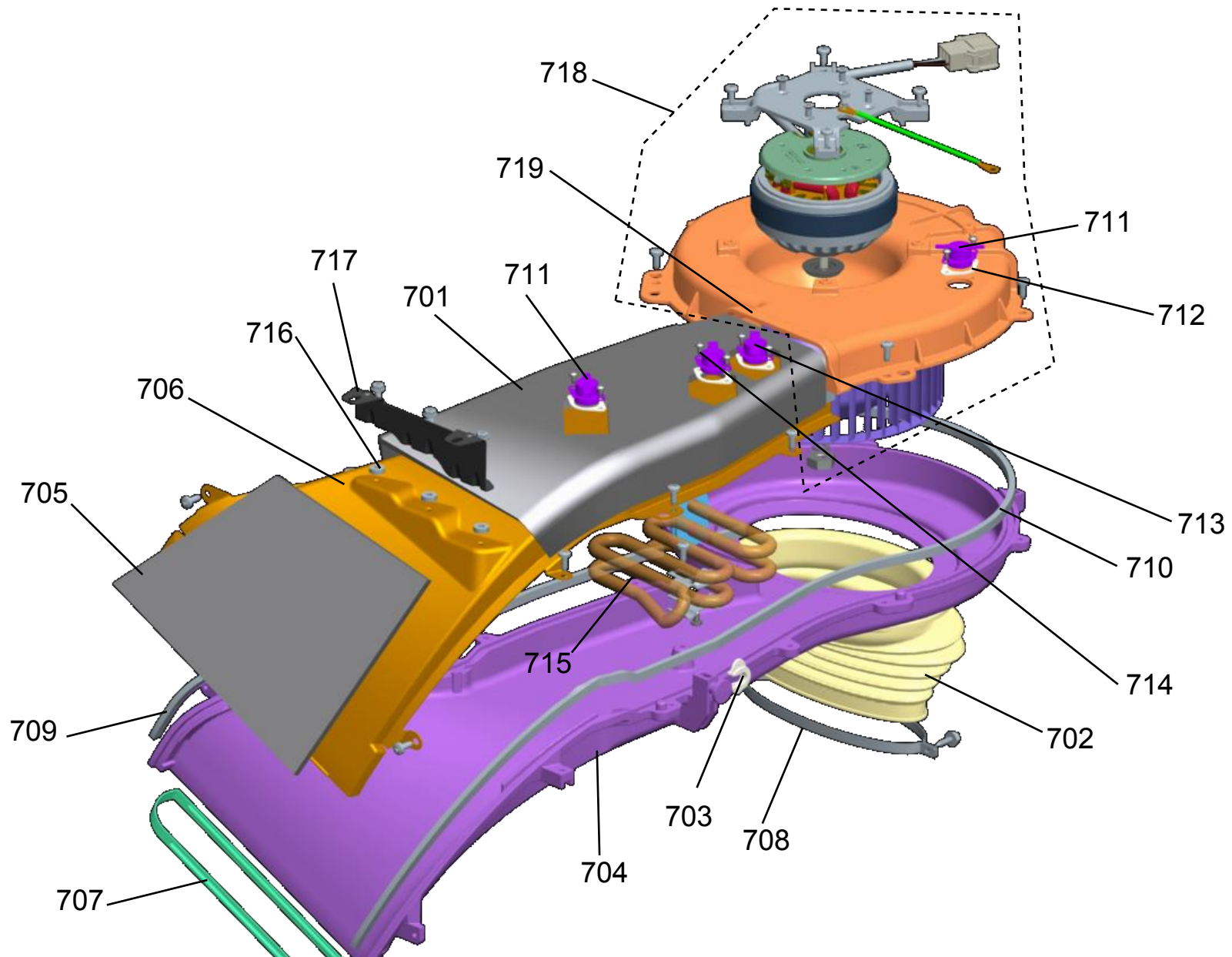

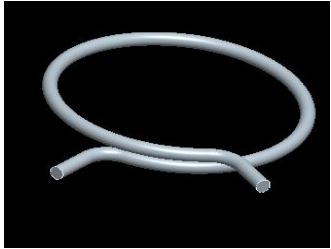
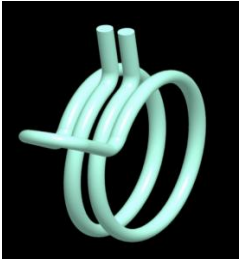
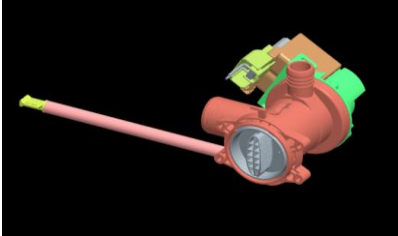
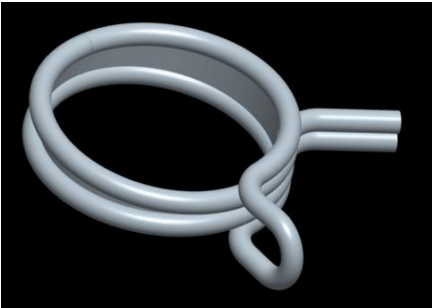
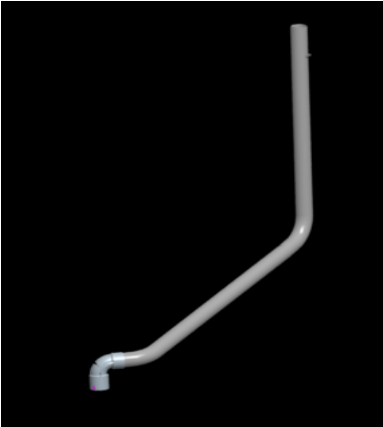



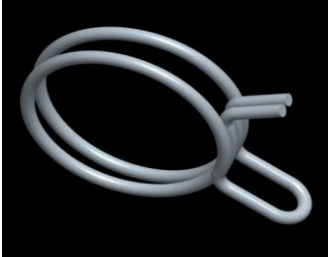

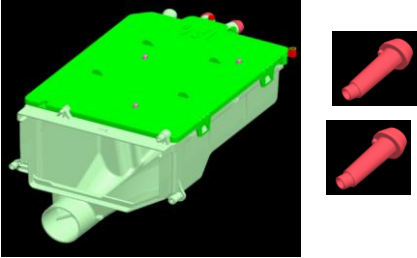
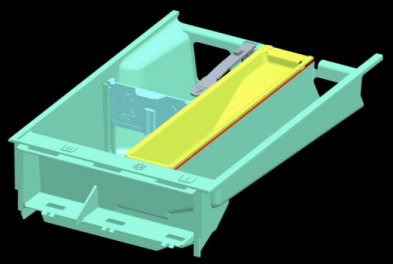

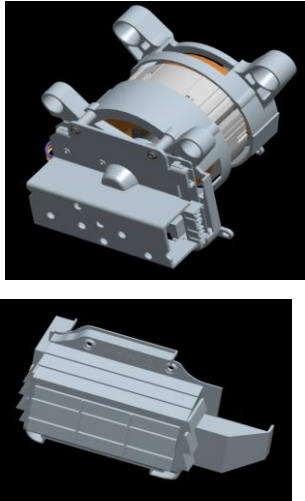
Detalhe de peças que possuem referência			
Desenho	Descrição	Código	Referencia
	ABRACADEIRA Tanque - Esfera Plastica	W10381364	208
	ABRACADEIRA BOMBA DRENAG 25197130405	W10616176	209
	BOMBA DE DRENAGEM 127 V	W10531768	210
	BOMBA DE DRENAGEM 220 V	W10531772	
	ABRACADEIRA Mang Drenag C301880	W10616180	211
	MANGUEIRA DRENAGEM, INTERNA	W10467594	212

Detalhe de peças que possuem referência

Desenho	Descrição	Código	Referência
	<p>ABRACADEIRA da Mang Dispenser C303538</p>	<p>W10616161</p>	<p>305</p>
	<p>W10620893</p>	<p>ABRACADEIRA C303539</p>	<p>306</p>
 	<p>CONJUNTO DISPENSER</p>	<p>W10449223</p>	<p>307</p>

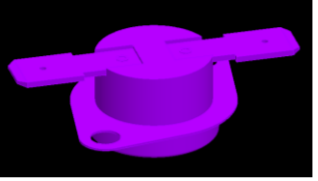
Detalhe de peças que possuem referência			
Desenho	Descrição	Código	Referencia
	MOTOR E INVERSOR 127 Cj	W10538125	514
	MOTOR E INVERSOR 220 Cj	W10566568	
	ESPALHADOR CONDENSADOR SECAGEM	W10448433	515
	GAXETA, ESPALHADOR CONDENSACAO	W10455504	516
	ALMOFADA DE AR 46197042681	W10616187	517
	DUTO, ALMOFADA DE AR	W10340639	518
	W10616185	ABRACADEIR A ReservatorioC3 00214	519
 <p>Resistencia + Sensor de temperatura</p>	W10473148	RESISTENCIA DE LAVAGEM 127 V	520
	W10473149	RESISTENCIA DE LAVAGEM 220 V	

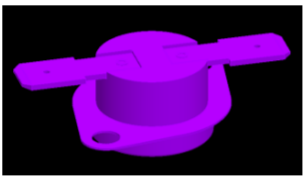
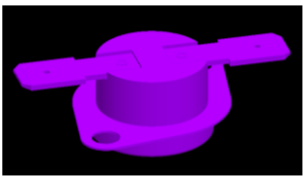
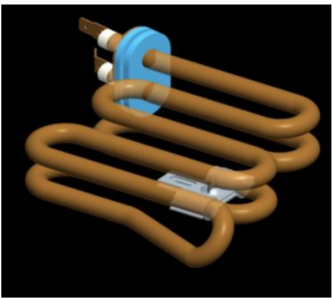
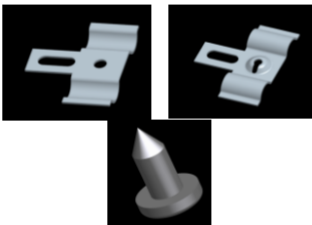
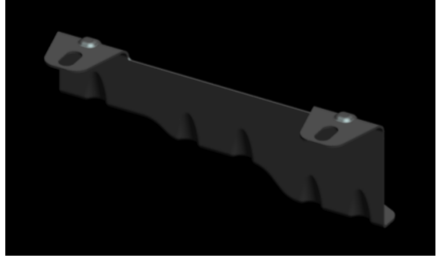
Detalhe de peças que possuem referência			
Desenho	Descrição	Código	Referencia
	DOBRADICA DA PORTA, COMBO	W10423260	607
	MOLDURA TRASEIRA, PORTA	W10423298	608
	GANCHO DA PORTA	W10423283	609
	MOLA, GANCHO DA PORTA	W10423284	610
	EIXO GANCHO PORTA 251967000301	W10616167	611
	COXIM, PORTA 461971428351	W10616165	612

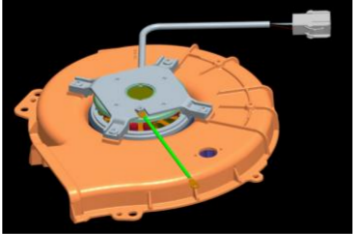
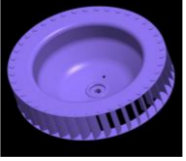
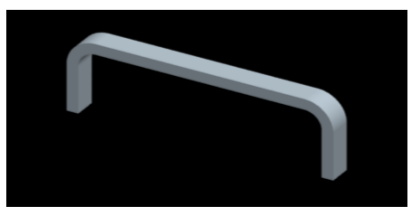
Detalhe de peças que possuem referência			
Desenho	Descrição	Código	Referencia
	GAXETA - 4X4X1128MM (W10613004)	W10632375	709
	GAXETA - 4X4X395MM (W10613005)	W10632370	710
 POSSUI CORPO MARROM E PONTO AZUL NO CENTRO	SENSOR NTC SECAGEM	W10511764	711
	GAXETA-NTC	W10495174	712
 POSSUI CORPO PRETO E PONTO LARANJA NO CENTRO	TERMOSTATO SEGURANCA 165 C	W10511763	713
 POSSUI CORPO MARROM E PONTO LARANJA NO CENTRO	TERMOSTATO DE SEGURANCA 180 C	W10566571	714
 	RESISTENCIA SECAGEM, 127 V	W10624639	715
	RESISTENCIA SECAGEM, 220 V	W10495186	
	SUPORTE UNIDADE SECAGEM	W10495187	716
	ARRUELA, UNIDADE DE SECAGEM	W10527044	717
 	CJ VENTONHA DE SECAGEM 127 V	W10537829	718
	CJ VENTONHA DE SECAGEM 220 V	W10534924	
	VEDACAO, UNIDADE SECAGEM	W10495184	719