

# Vista Explodida do Produto

---

<b>Categoria do Produto</b>	<b>Máquina de Bebidas</b>	<b>Em caso de dúvida, entre em contato com o CDP Códigos através de uma Solicitação de Serviços no CRM</b>
<b>Marcas do Produto</b>	<b>Brastemp</b>	
<b>Modelo</b>	<b>BPG40C</b>	

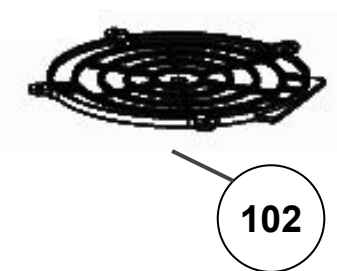

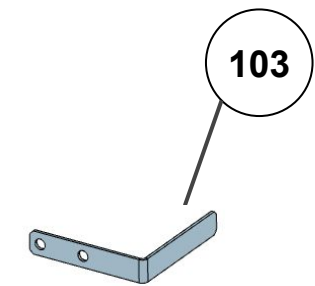
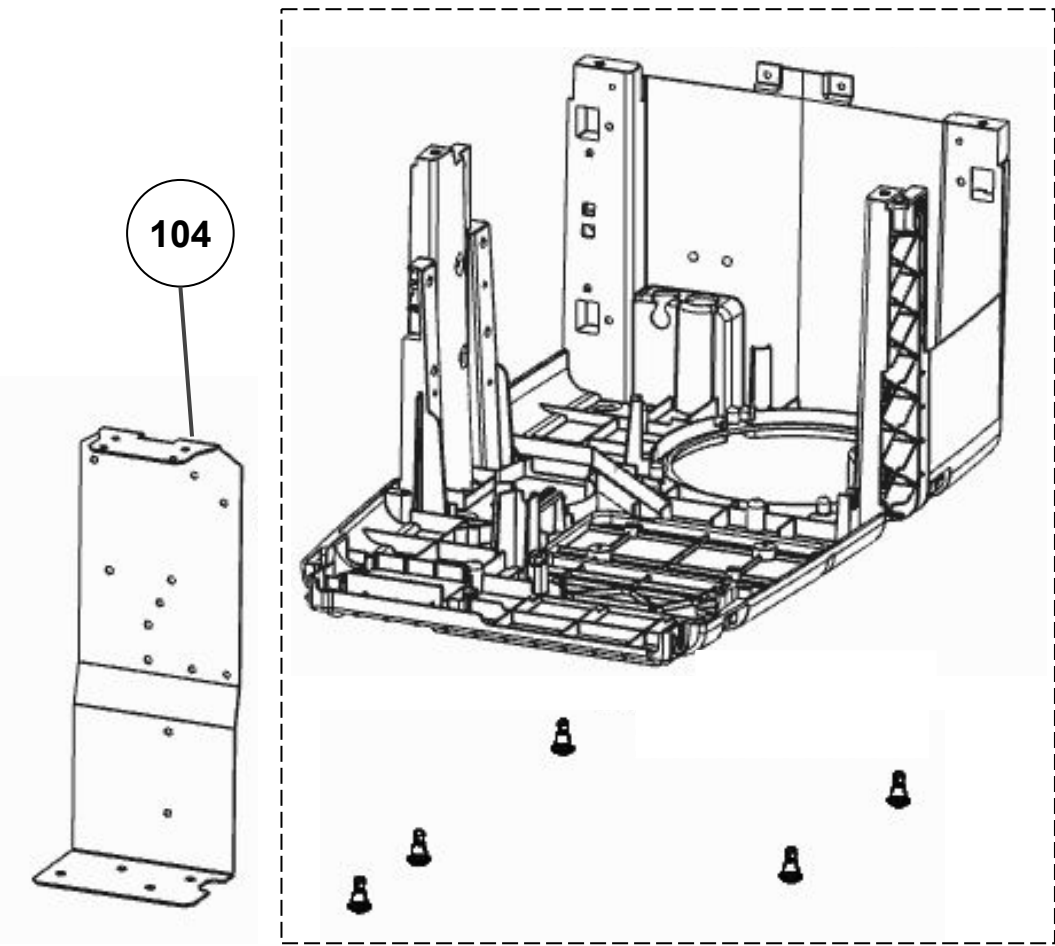
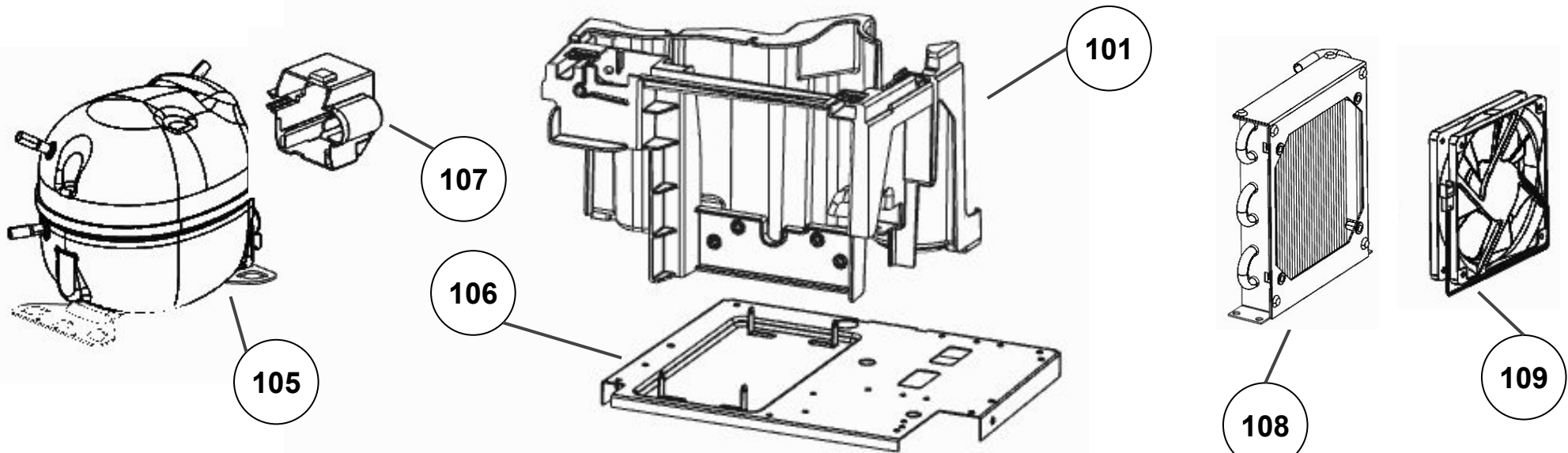

\*

As peças indicadas com Asterisco (\*) não são de reposição. Caso seja necessário a troca de uma destas peças, deverá ser aberta Solicitação de Serviços (via CRM) para aplicação da Política de Atendimento.

Abaixo, segue o passo a passo para abertura da Solicitação de Serviços:

**Fase:** Diagnóstico/Reparo  
**Categoria 1:** Produto não tem solução técnica ou peça reposição.

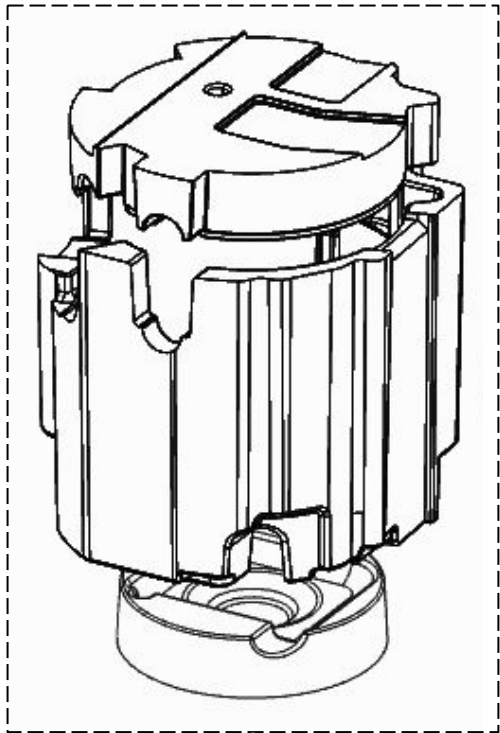

110

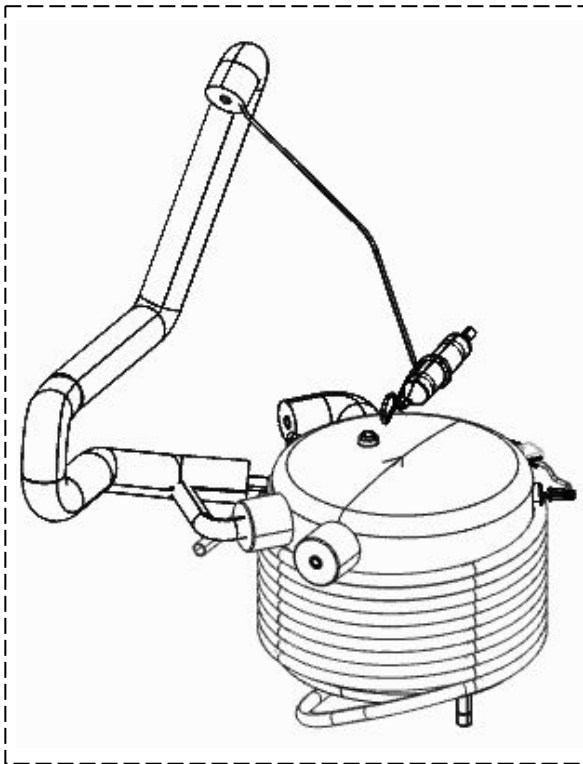

111



147

113



206

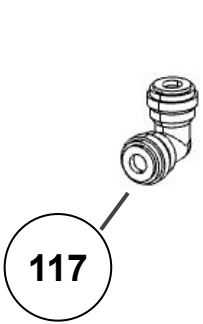

117

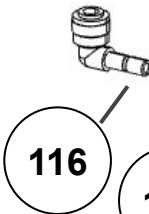

116

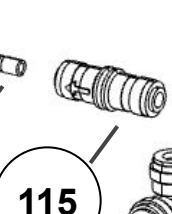

115

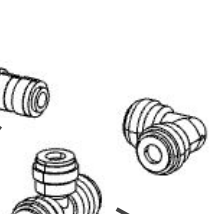

118

114

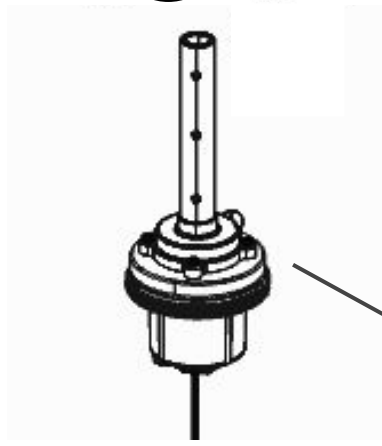

112

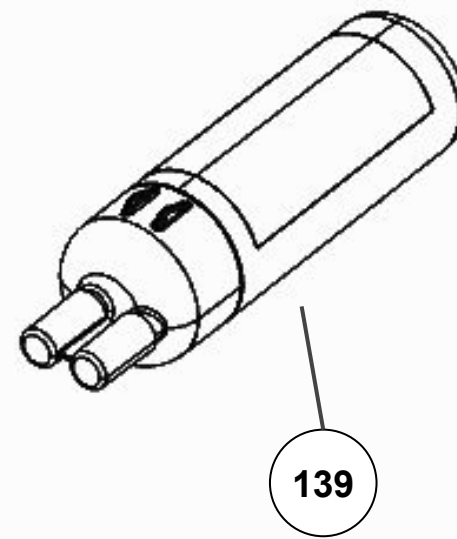
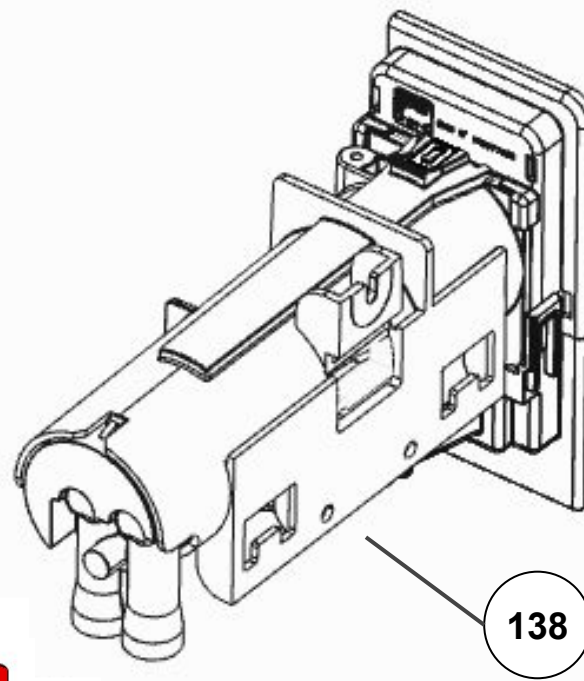
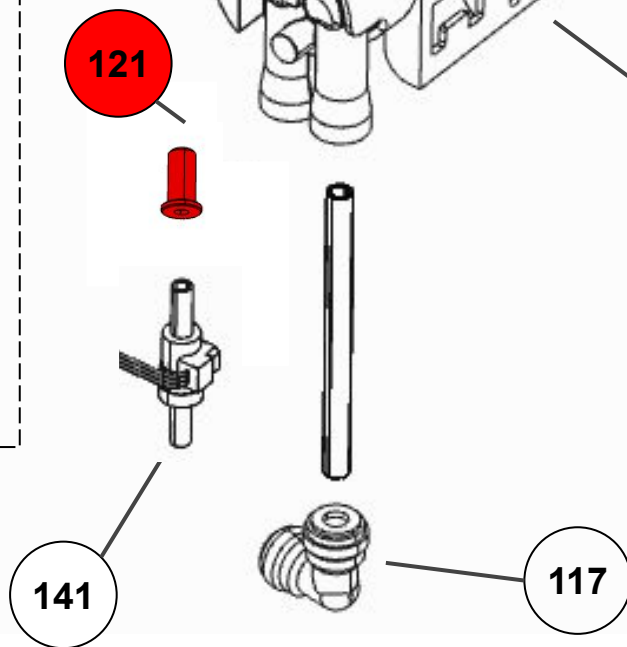
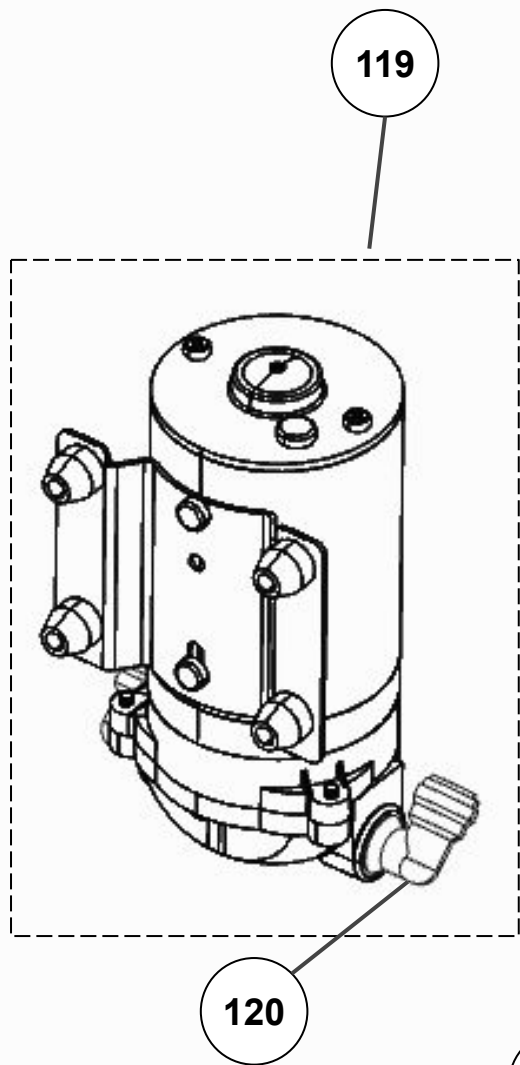
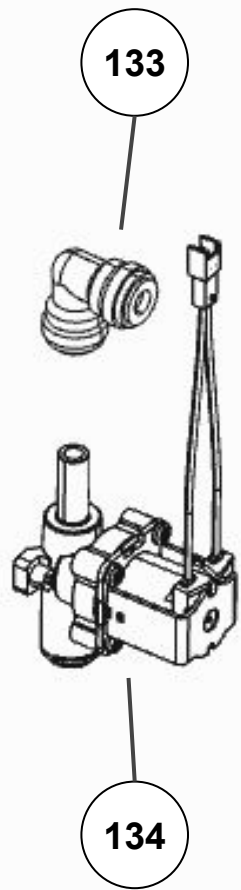





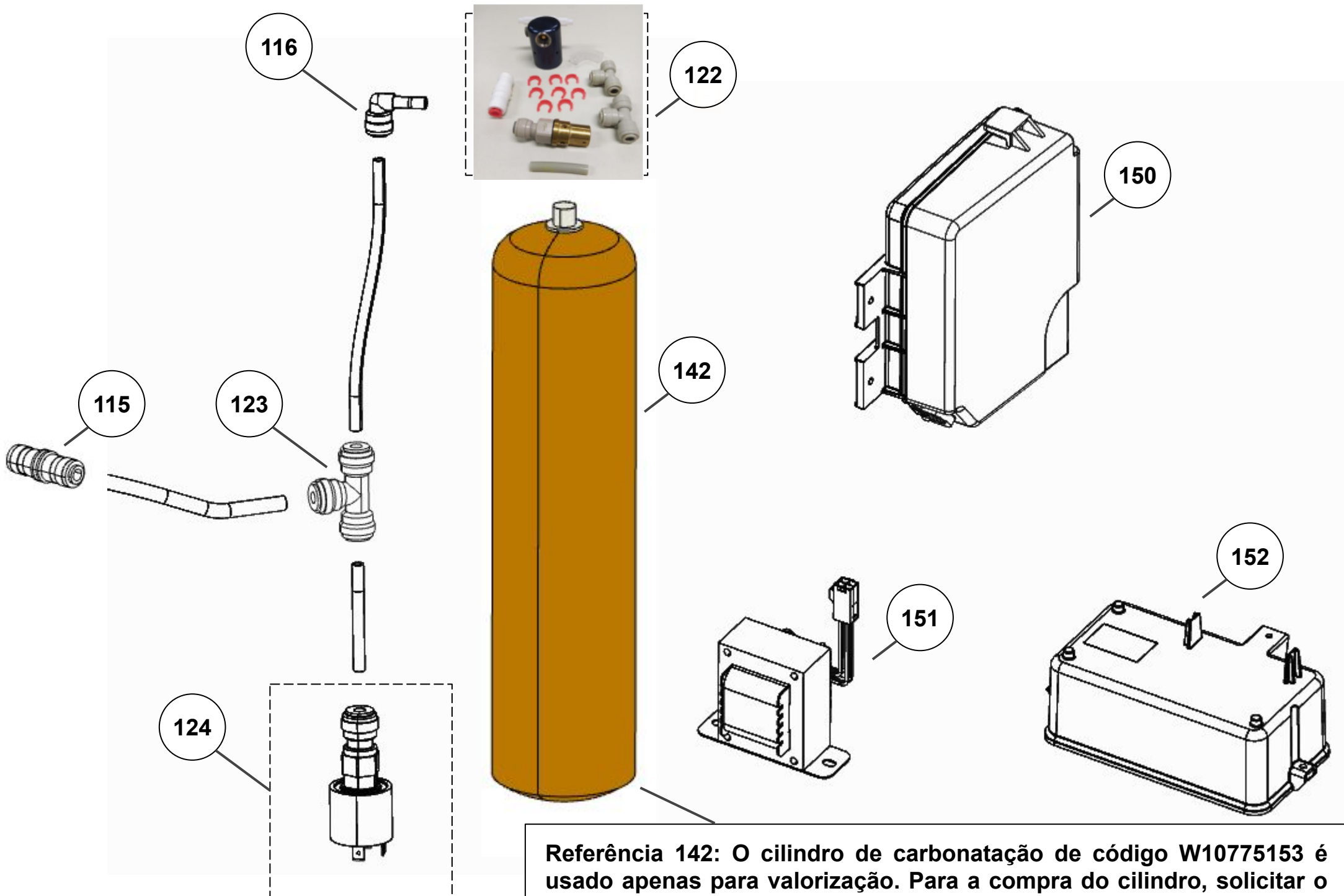

**Referência 142: O cilindro de carbonatação de código W10775153 é usado apenas para valorização. Para a compra do cilindro, solicitar o código W10798373 (Este não está cadastrado no catálogo de peças)**

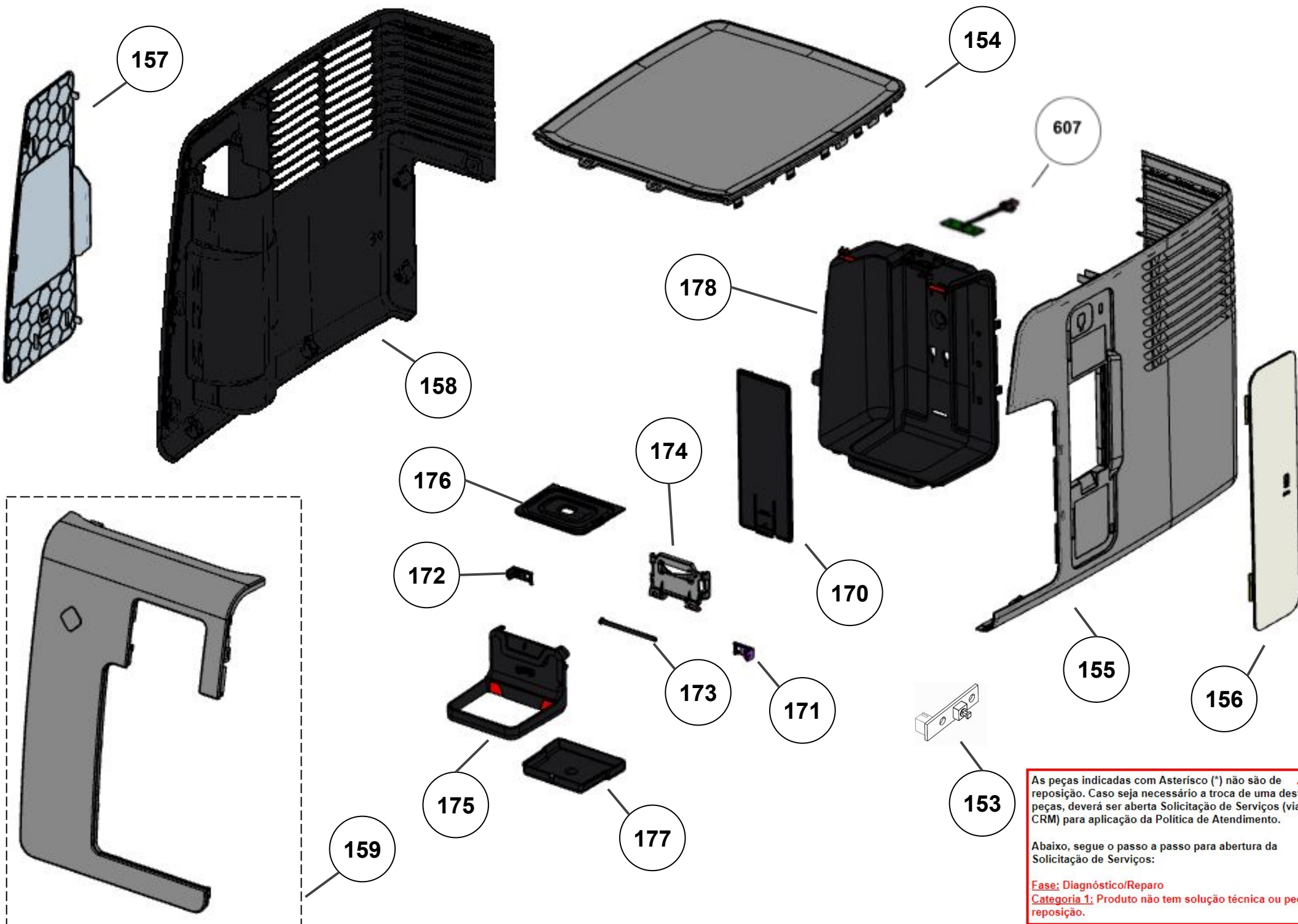

As peças indicadas com Asterisco (\*) não são de reposição. Caso seja necessário a troca de uma destas peças, deverá ser aberta Solicitação de Serviços (via CRM) para aplicação da Política de Atendimento.

Abaixo, segue o passo a passo para abertura da Solicitação de Serviços:

**Fase:** Diagnóstico/Reparo  
**Categoria 1:** Produto não tem solução técnica ou peça reposição.

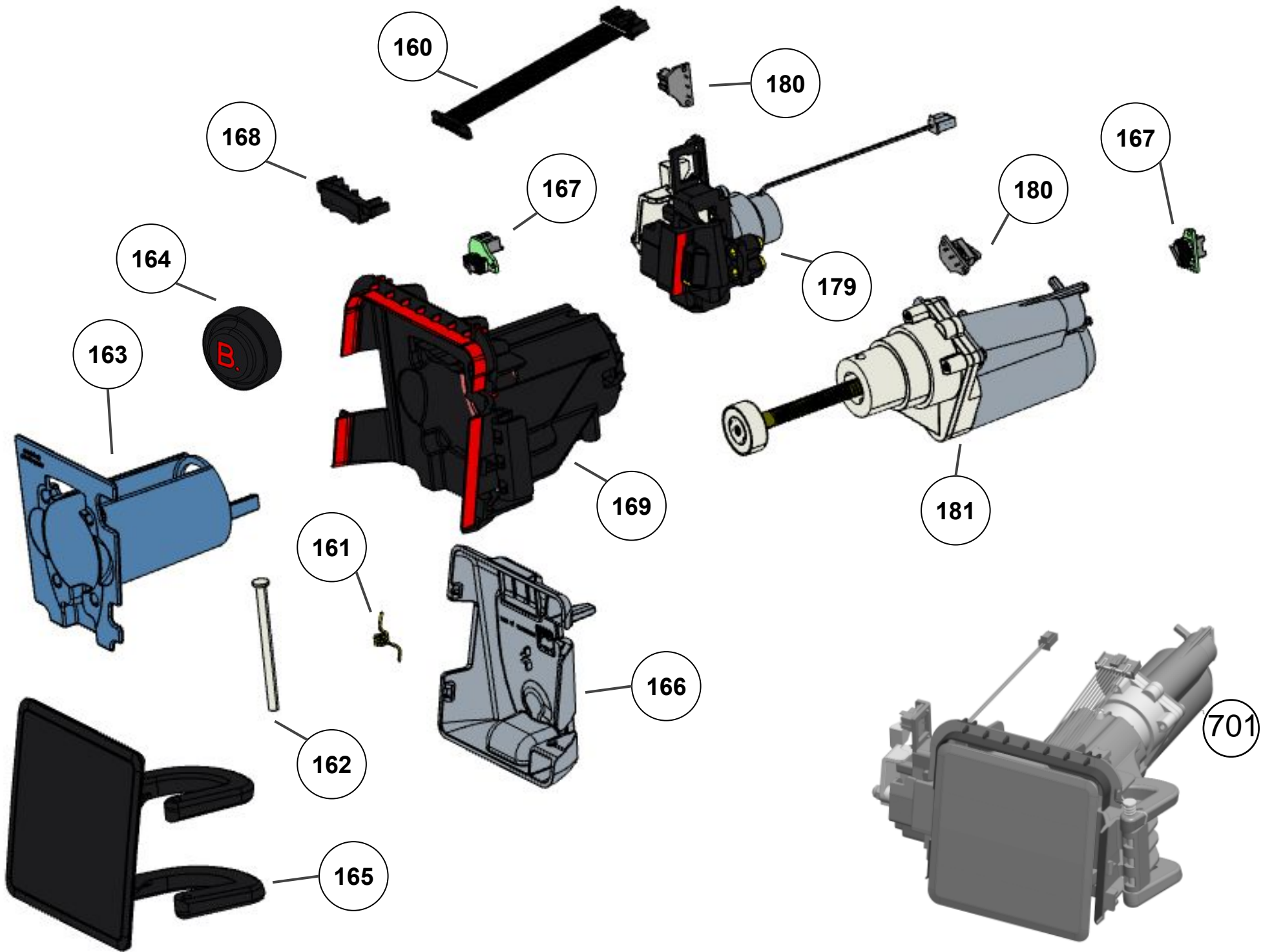



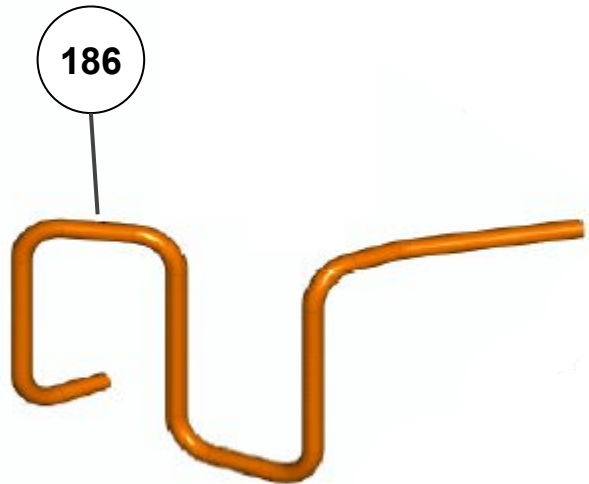

183

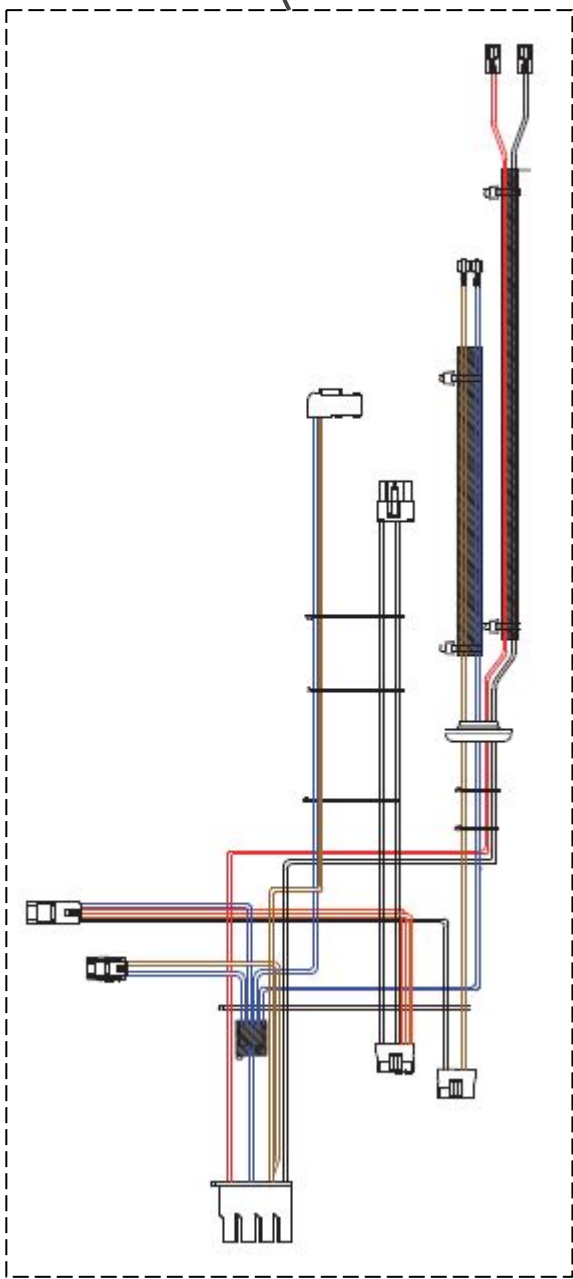

184

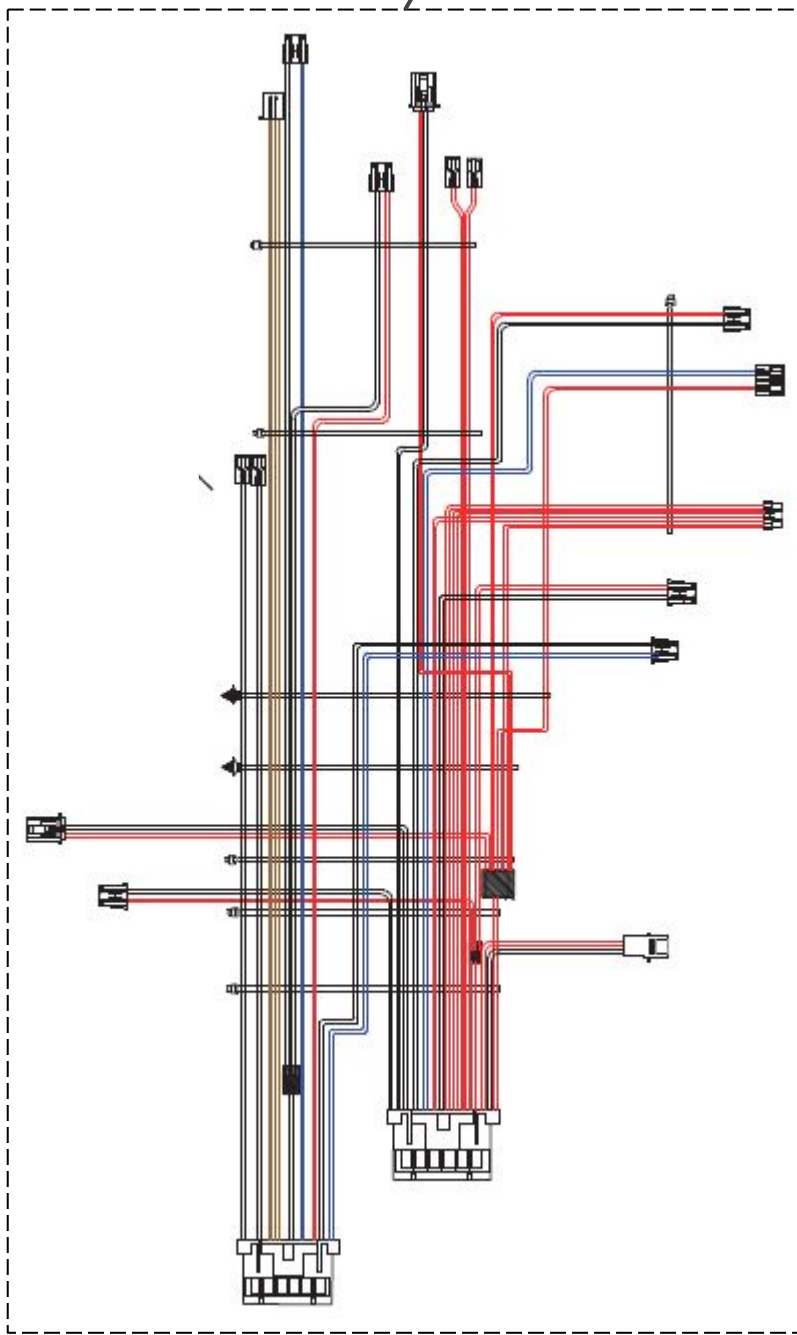

185

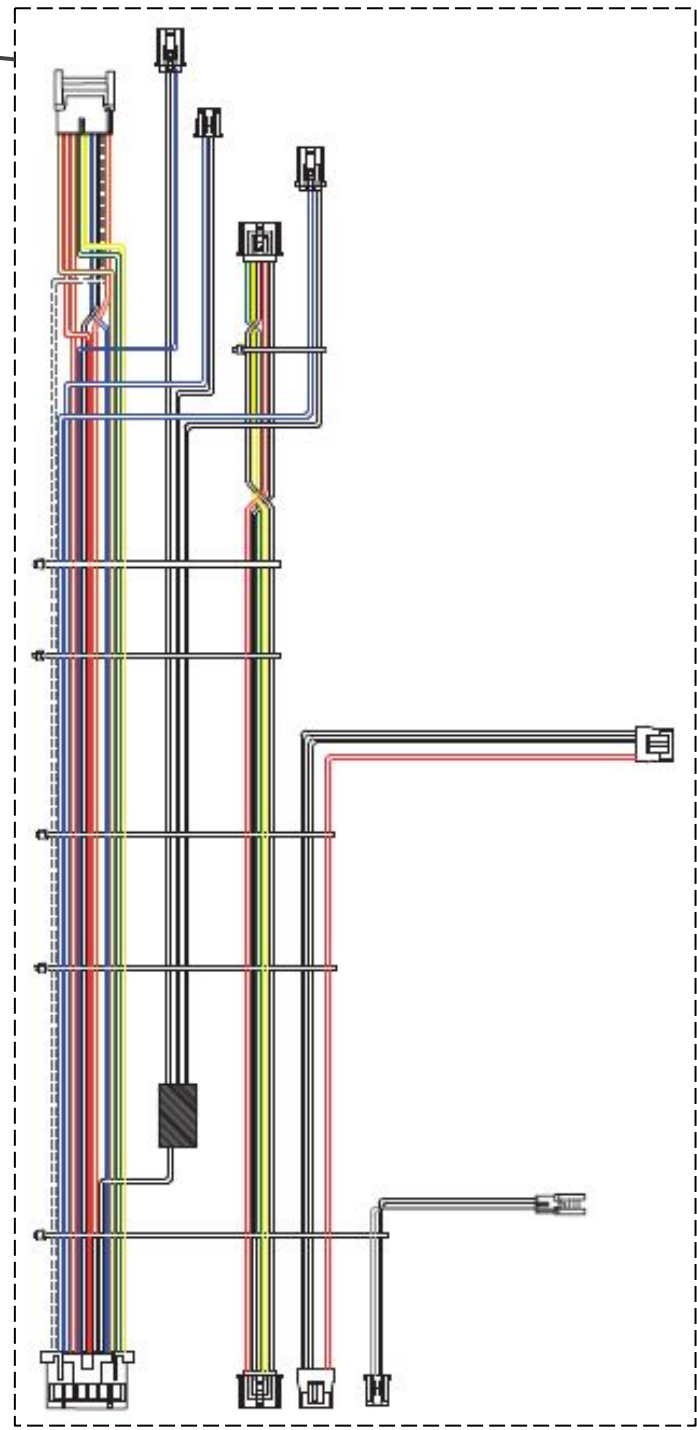

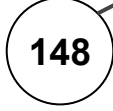
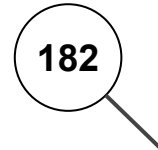
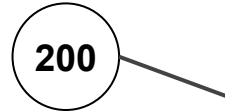
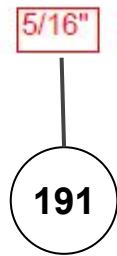
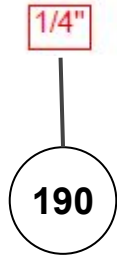
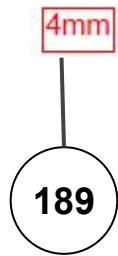
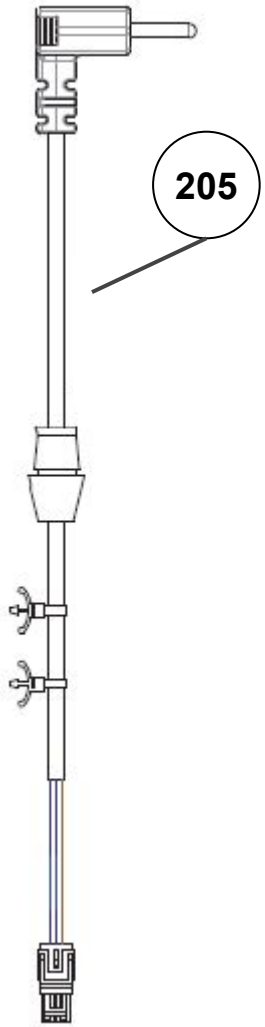

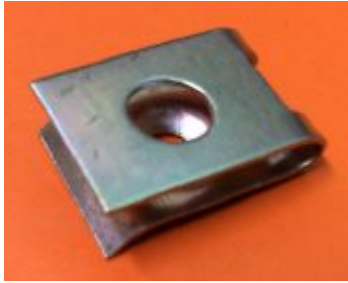

188



194

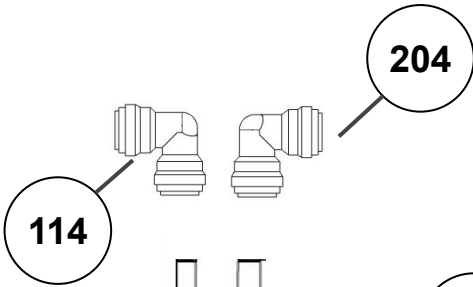

114

204

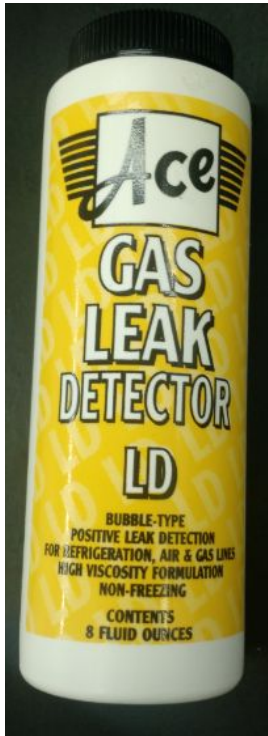

197



609

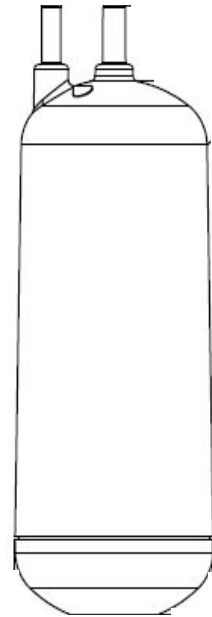

192



608

193

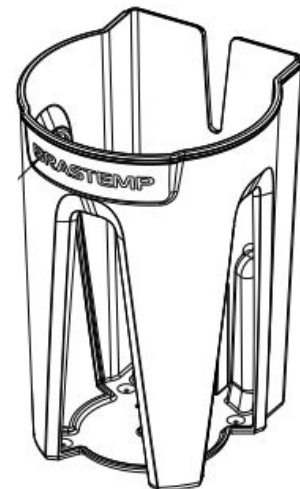

202

CONTROLE DE REVISÕES

REVISÃO	DATA	EDIÇÃO	PUBLICAÇÃO
R1	05/10/2020	F.M.	O.J.