

Vista Explodida do Produto

Categoria do Produto	Máquina de Bebidas	Em caso de dúvida, entre em contato com o CDP Códigos através de uma Solicitação de Serviços no CRM
Marcas do Produto	Brastemp	
Modelo	BPG40C	

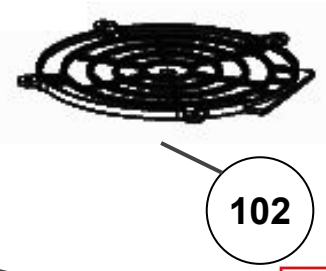

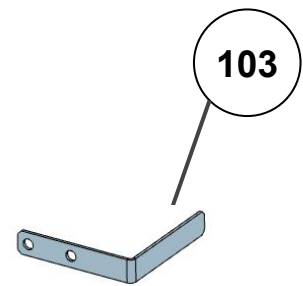
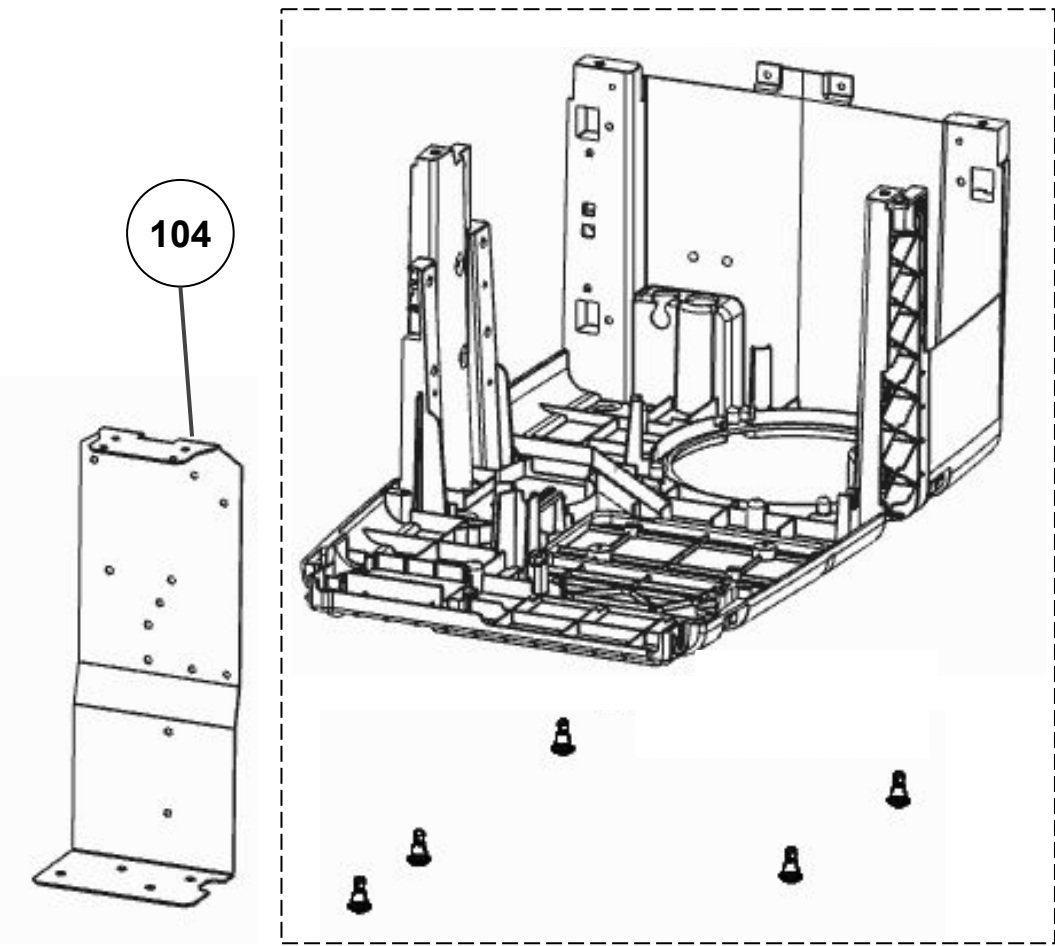
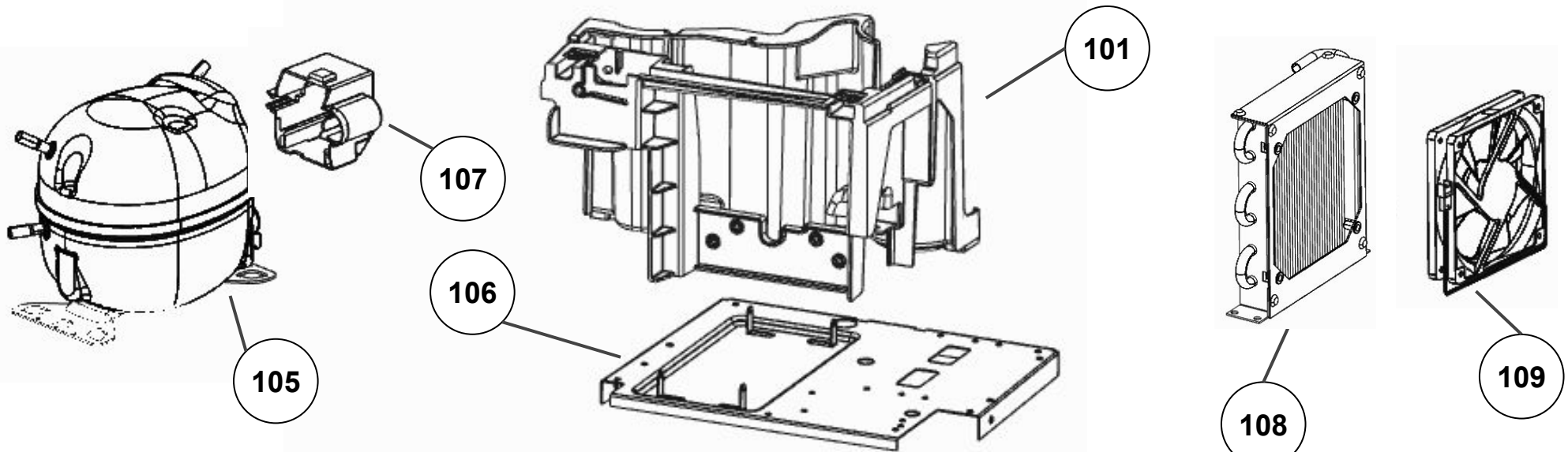

As peças indicadas com Asterisco (*) não são de reposição. Caso seja necessário a troca de uma destas peças, deverá ser aberta Solicitação de Serviços (via CRM) para aplicação da Política de Atendimento.

Abaixo, segue o passo a passo para abertura da Solicitação de Serviços:

Fase: Diagnóstico/Reparo
Categoria 1: Produto não tem solução técnica ou peça reposição.

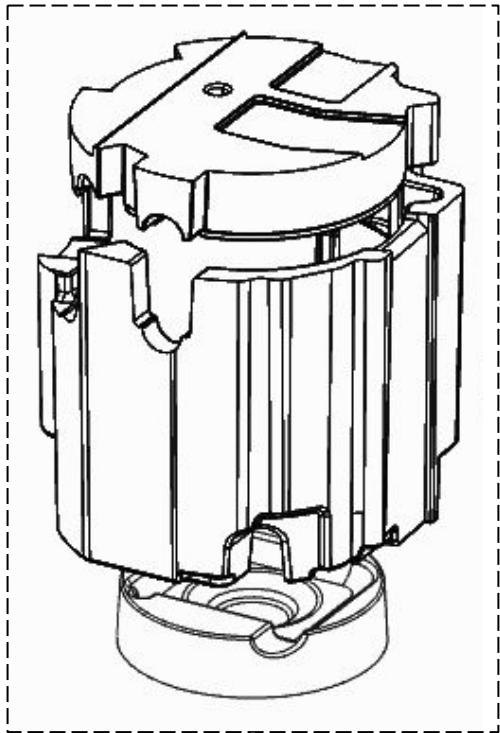

110

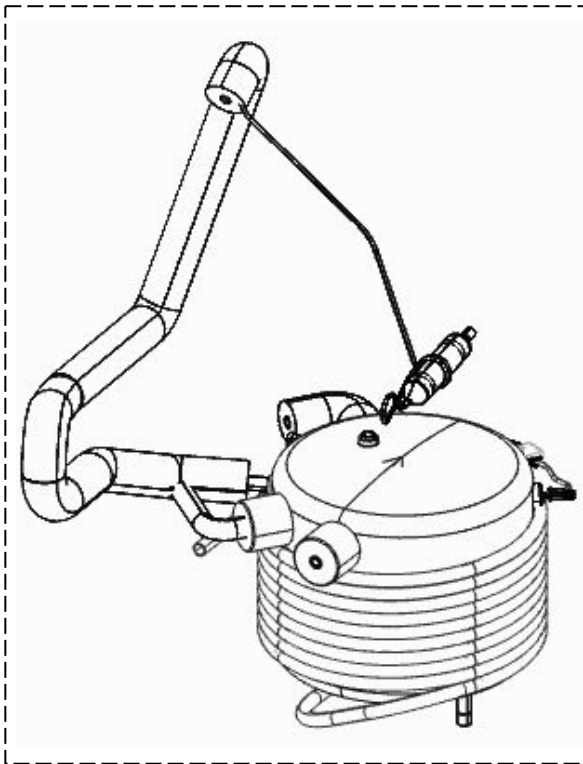

111



147

113



206

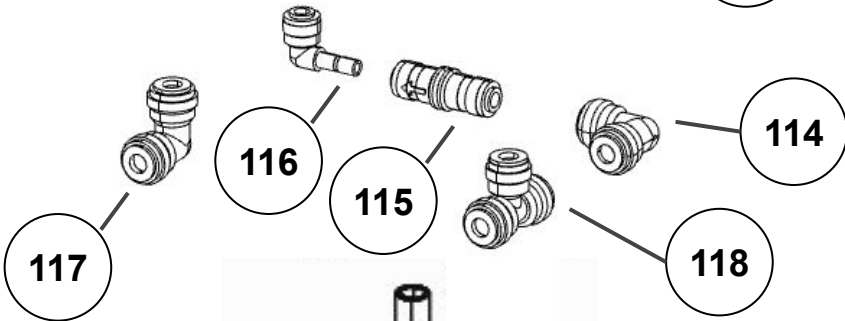

117

116

115

118

114

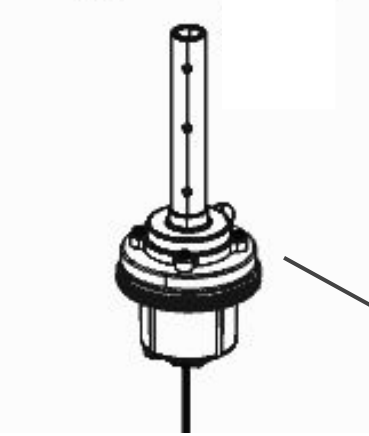

112

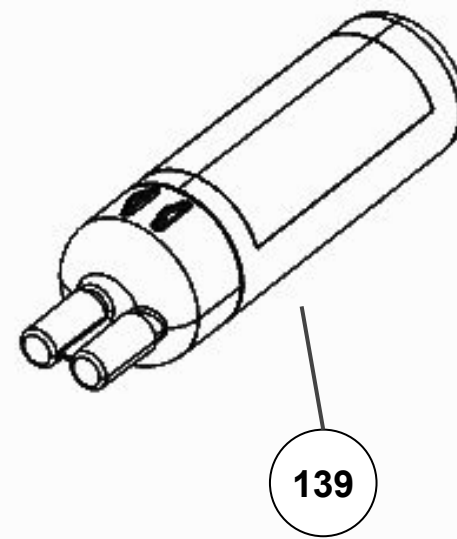
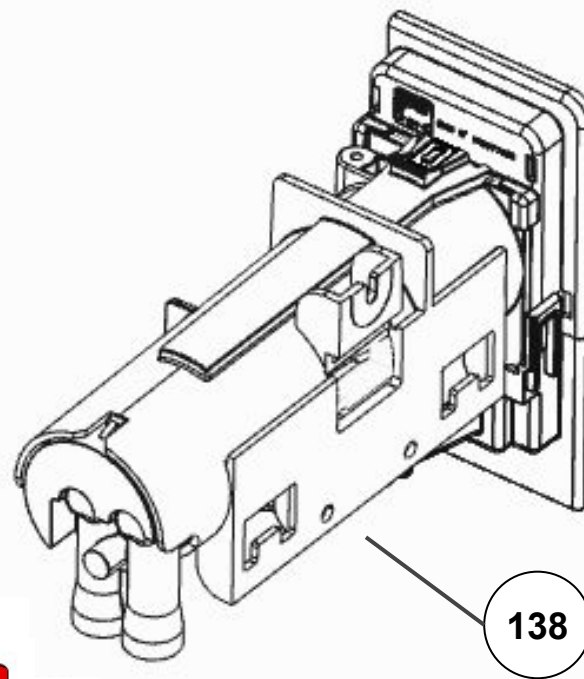
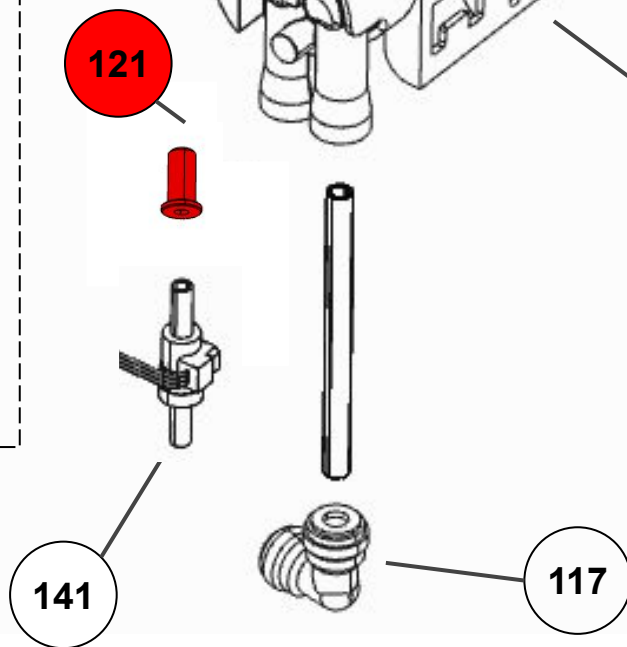
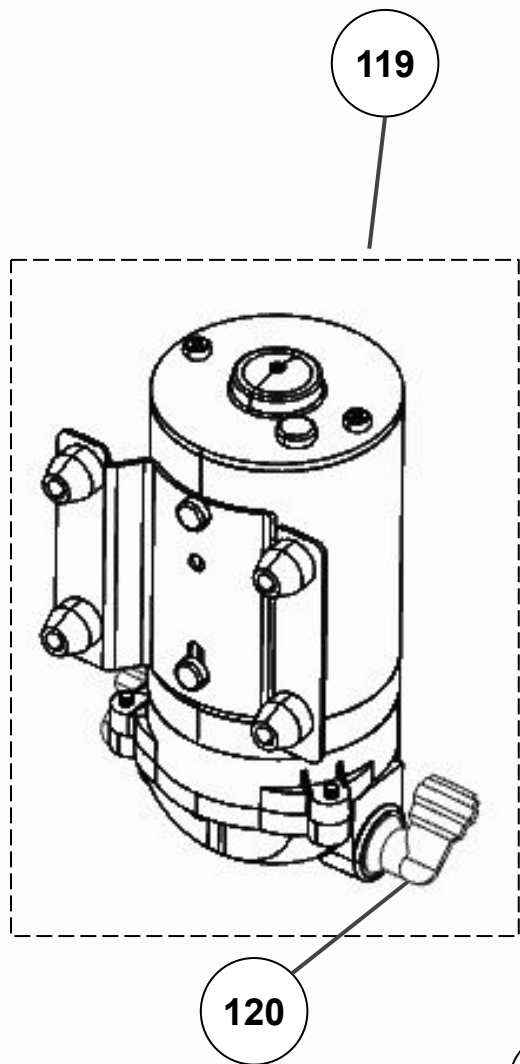
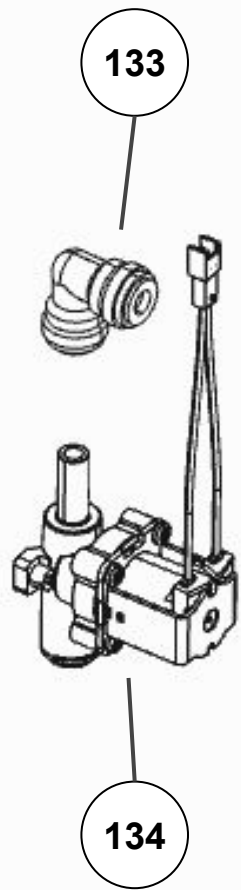

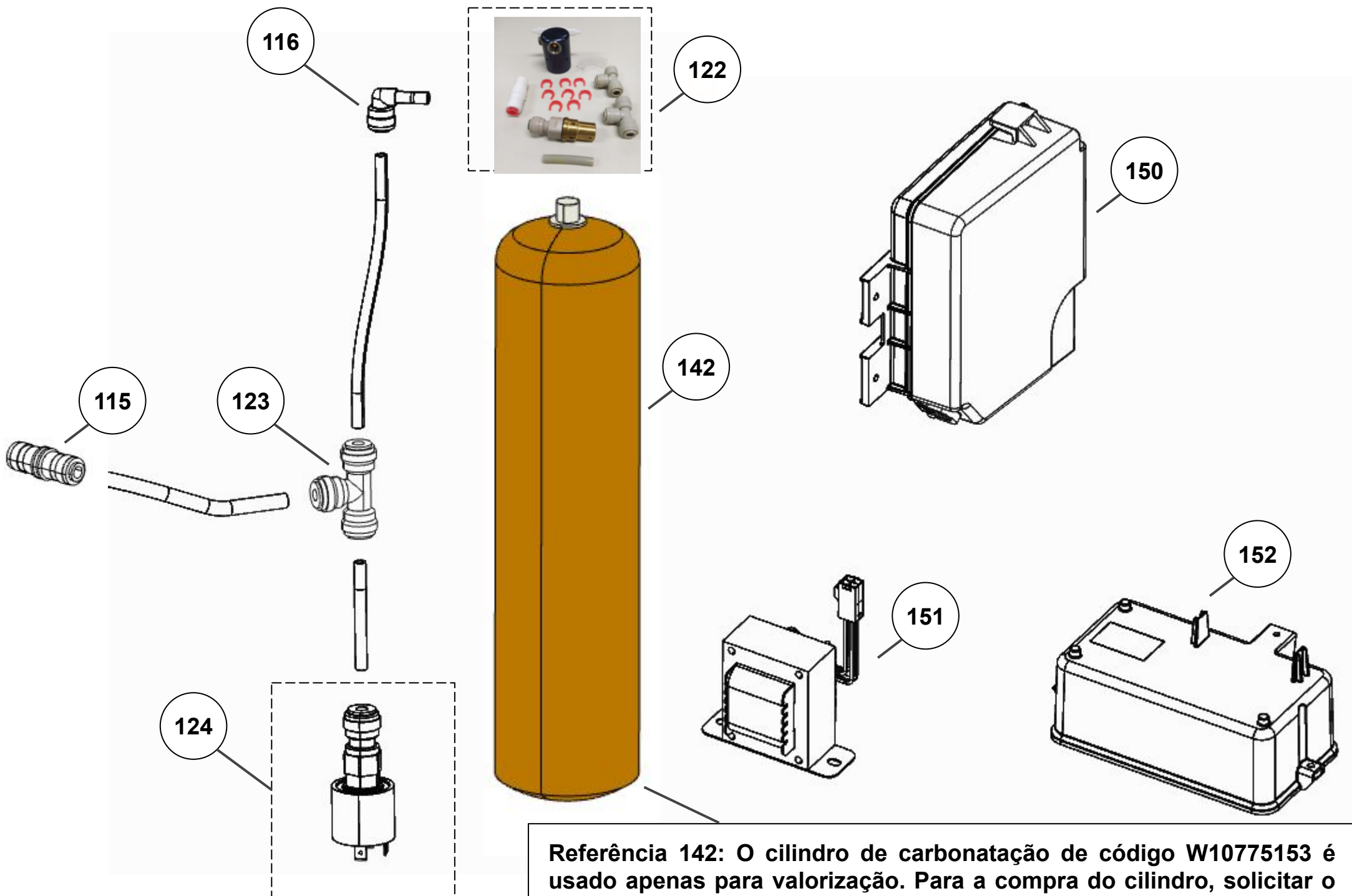

Referência 142: O cilindro de carbonatação de código W10775153 é usado apenas para valorização. Para a compra do cilindro, solicitar o código W10798373 (Este não está cadastrado no catálogo de peças)

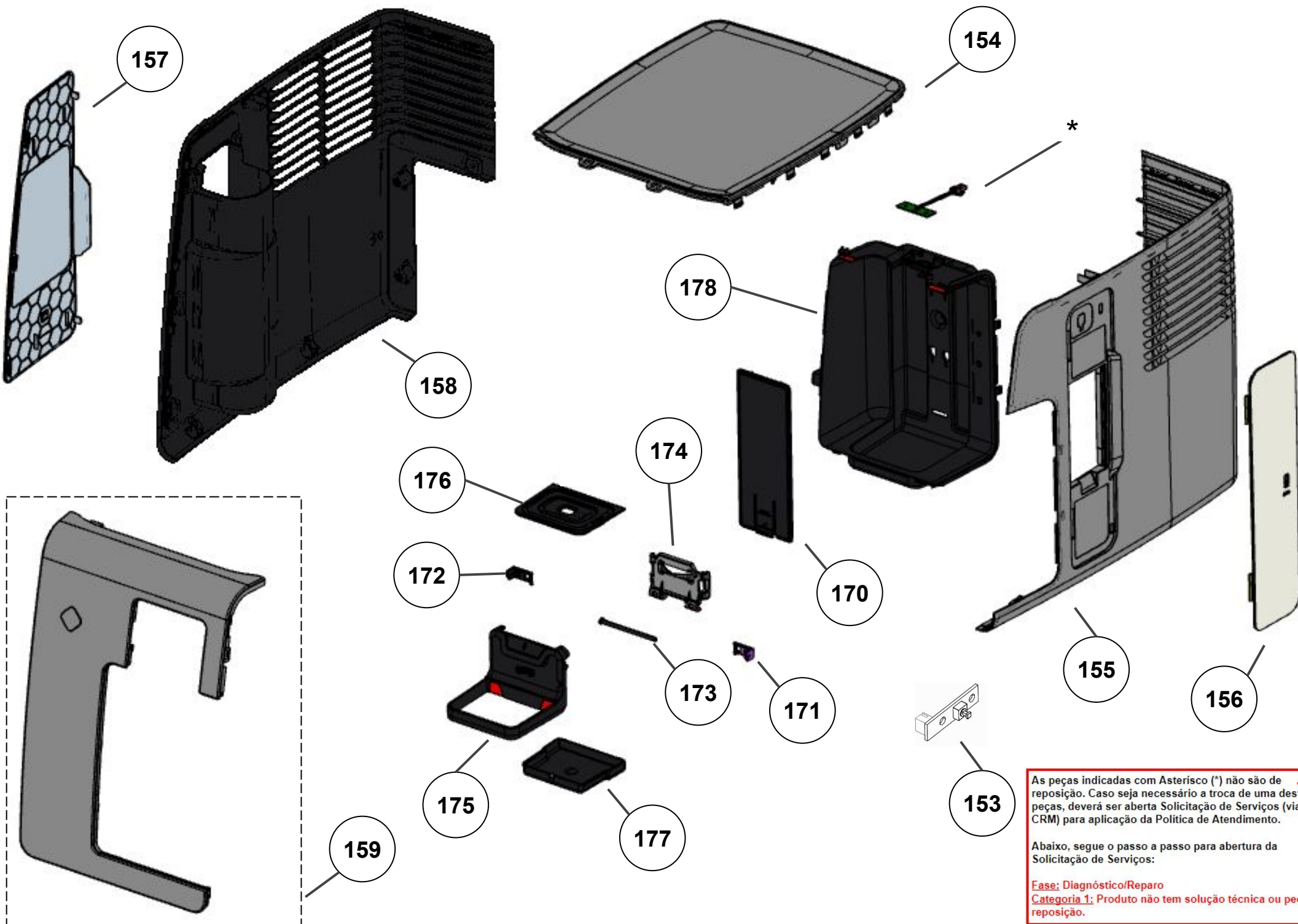

As peças indicadas com Asterisco (*) não são de reposição. Caso seja necessário a troca de uma destas peças, deverá ser aberta Solicitação de Serviços (via CRM) para aplicação da Política de Atendimento.

Abaixo, segue o passo a passo para abertura da Solicitação de Serviços:

Fase: Diagnóstico/Reparo
Categoria 1: Produto não tem solução técnica ou peça reposição.

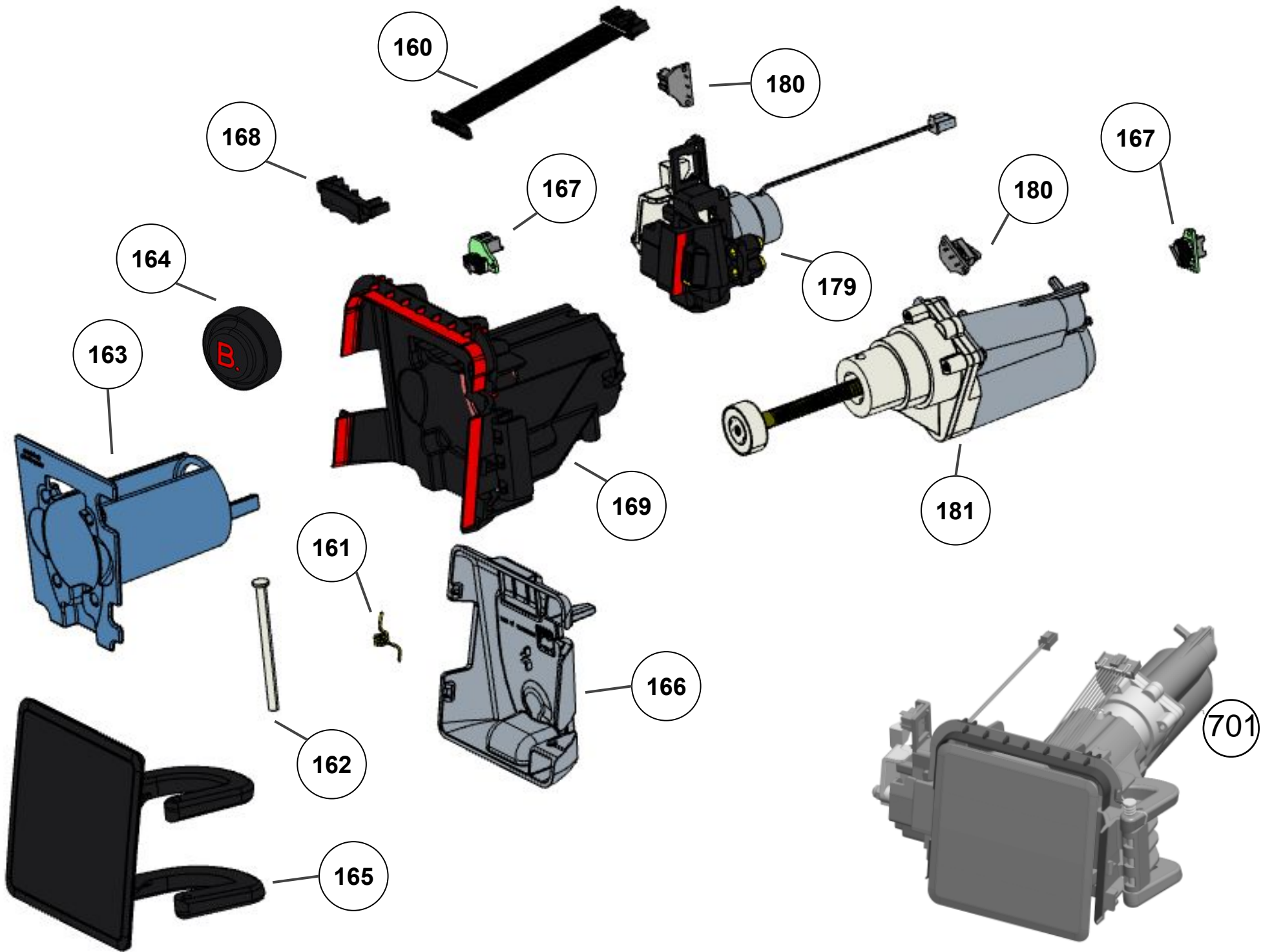

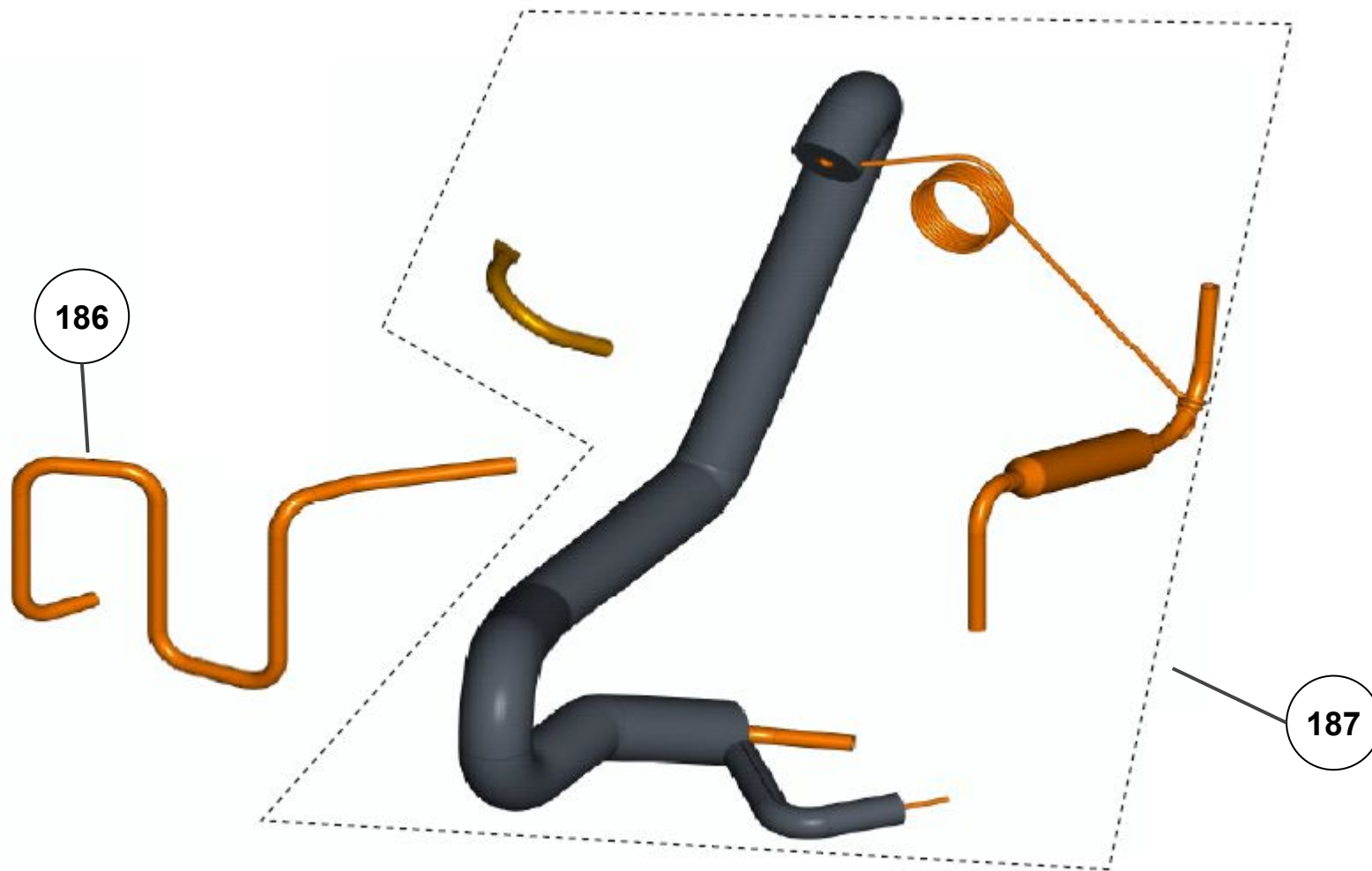

183

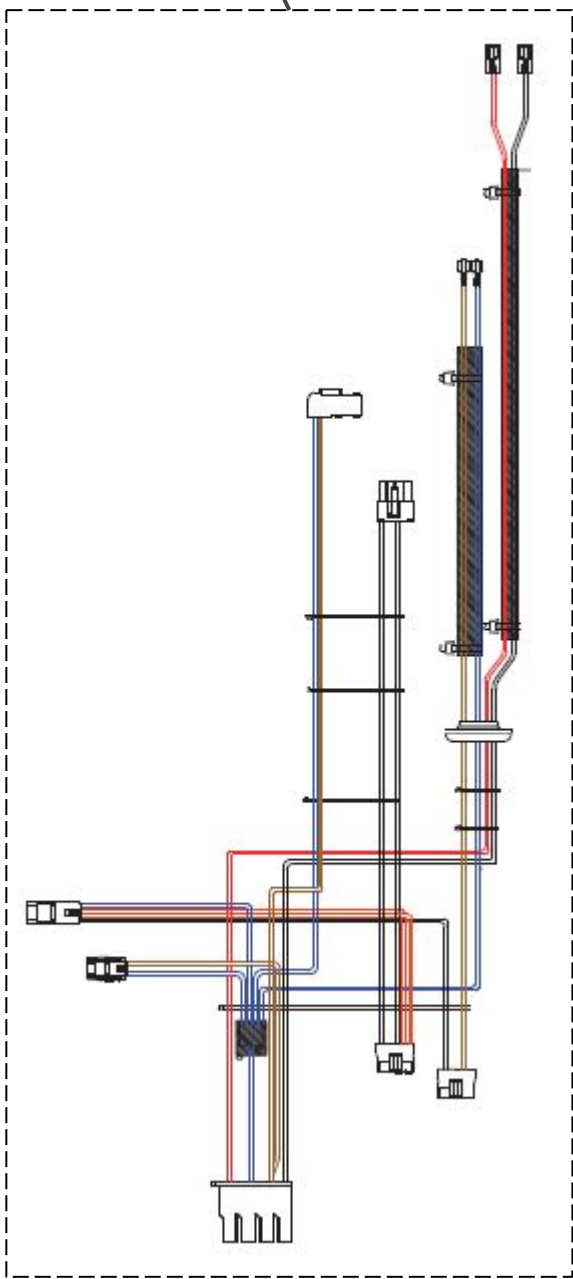

184

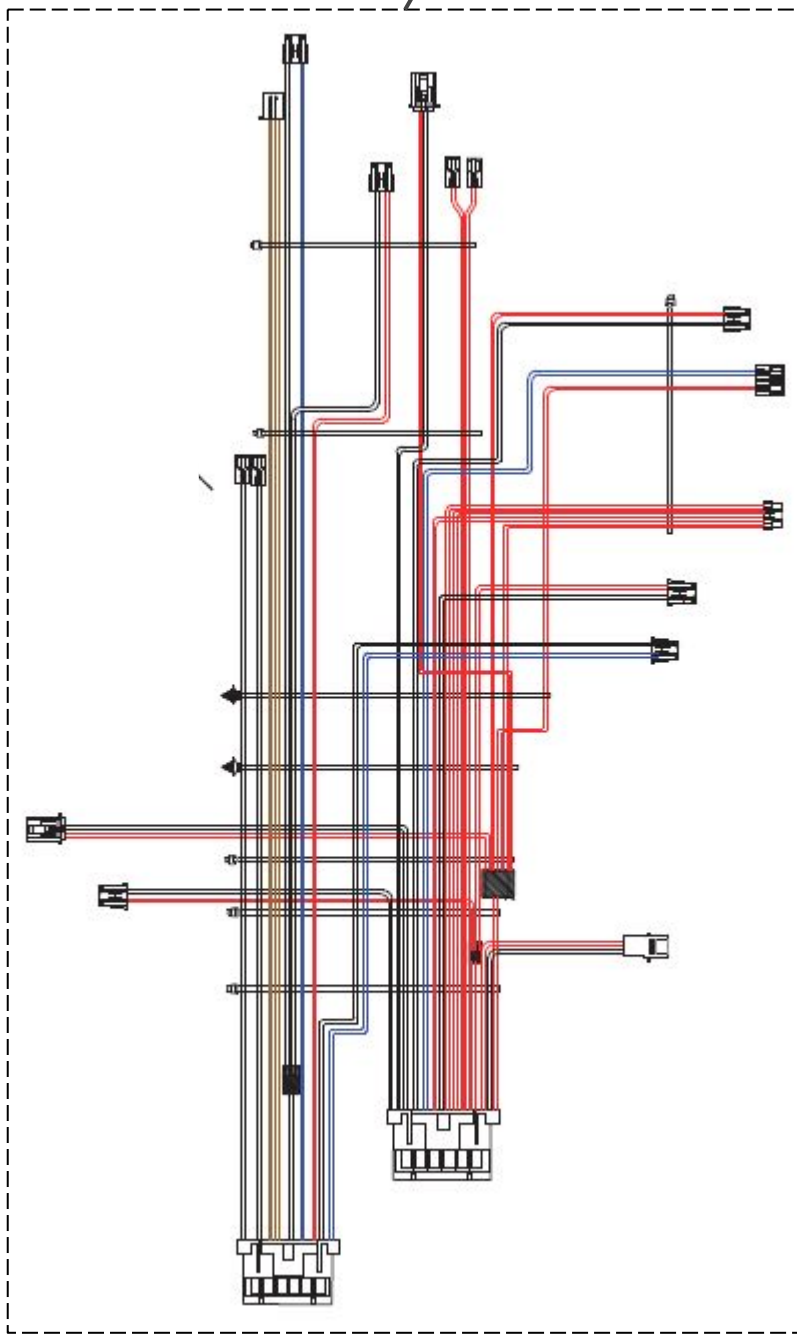

185

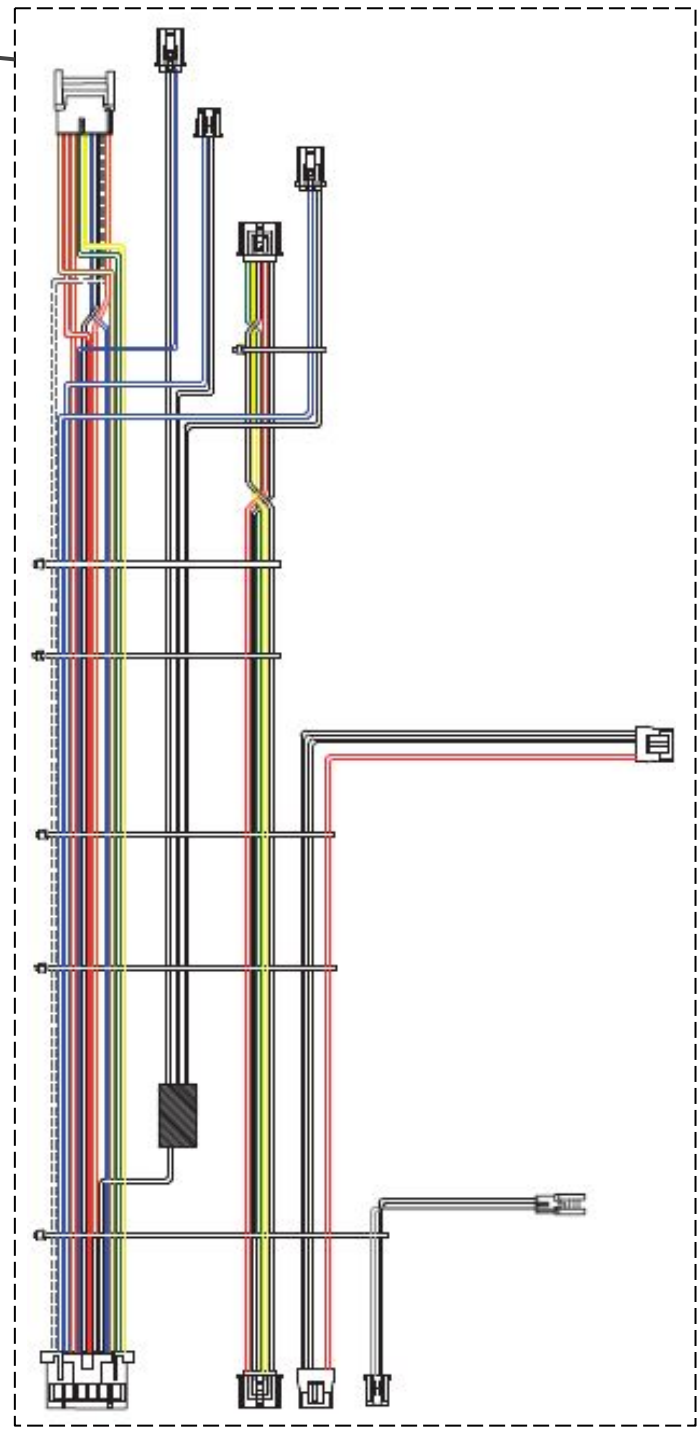

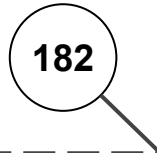
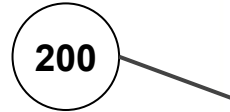
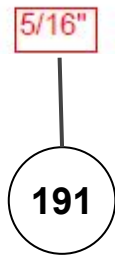
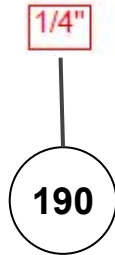
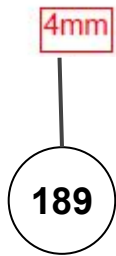
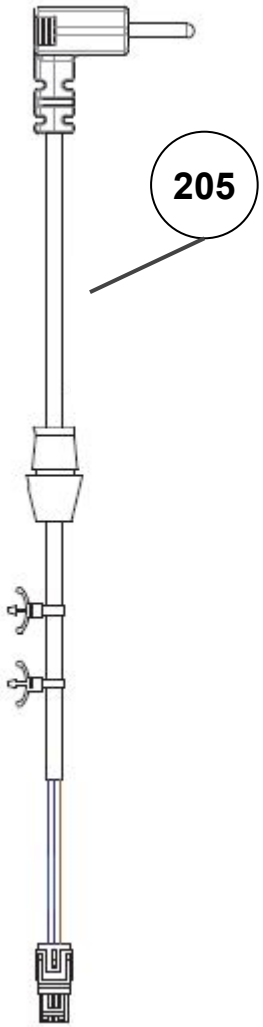

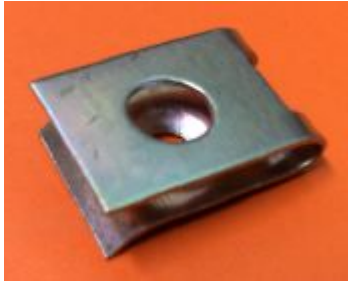

188



194

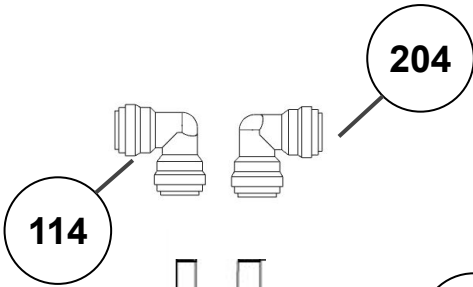

114

204

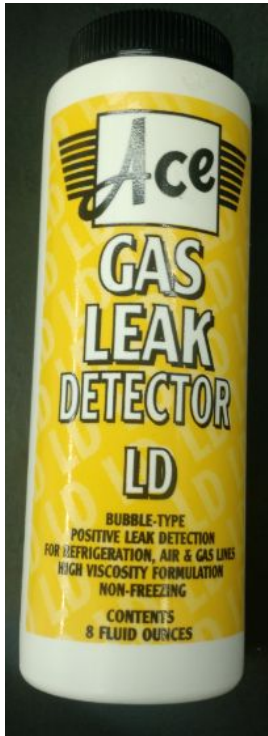

197

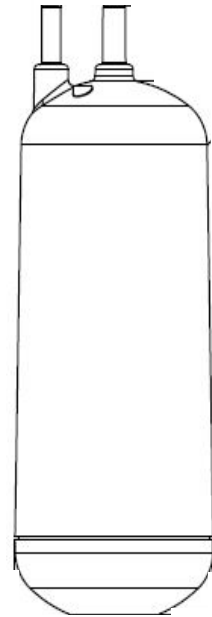

192

193

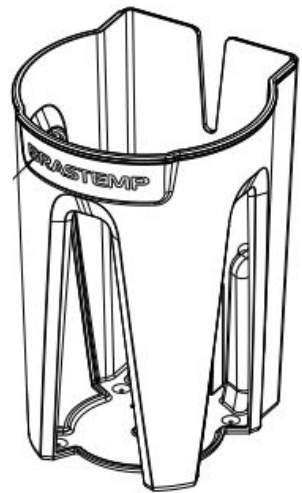

202

CONTROLE DE REVISÕES

REVISÃO	DATA	EDIÇÃO	PUBLICAÇÃO
R1	05/10/2020	F.M.	O.J.