

BRASTEMP

CATÁLOGO DE PEÇAS

Refrigeradores Brastemp Inverse *Ative*

BRE50NB

Revisão	Motivo	Páginas Alteradas	Elaborado Por	Revisado Por	Data
R0.0	Lançamento		Felipe P. Lordello	Rafaela S Matos	25/09/12
R1.0	Projeto Venturi	todas	Cassiano	Anderson Batista	15/02/15

COMUNICADO IMPORTANTE

Novas versões de produto

A partir de 21 de janeiro de 2014, iniciamos a produção das novas versões de engenharia desse produto.







PRODUTOS ANTIGOS



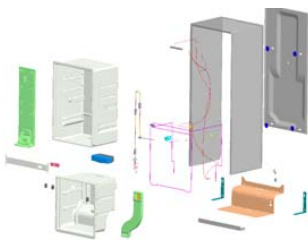
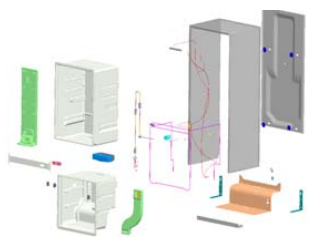

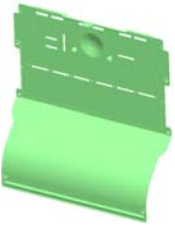

- Versões de engenharia desde a 0.0 até a 7.0

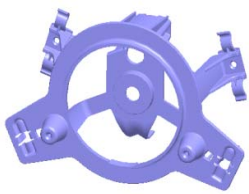

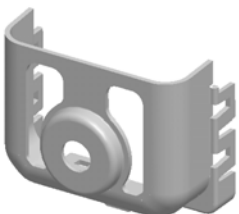

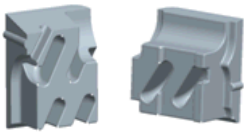
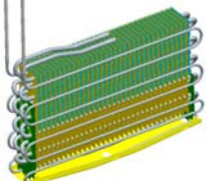
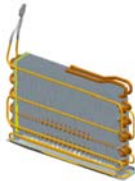
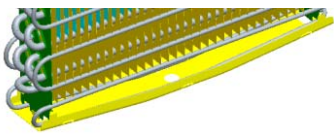
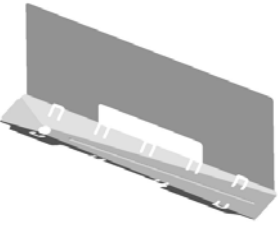
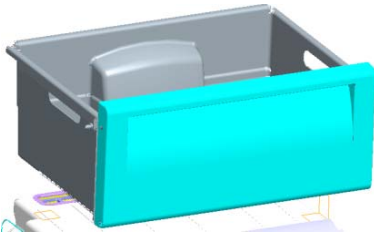
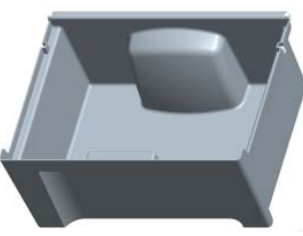

PRODUTOS NOVOS

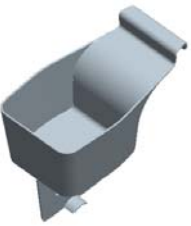
- Versões de engenharia iniciando da 8.0 em diante

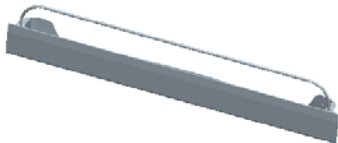
O que alterou nos produtos novos?

Descrição	Antigo	Novo
GABINETE EMBALADO		
CAPA FRONTAL EVAPORADOR		
CAPA INTERMEDIÁRIA EVAPORADOR		
SUPORTE MOTOR VENTILADOR		

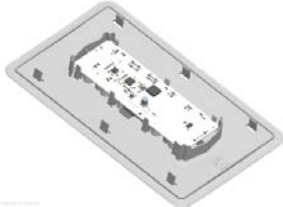
<p>TAMPA SUPORTE MOTOR VENTILADOR</p>		
<p>MOTOR VENTILADOR</p>		
<p>CALÇO DO EVAPORADOR</p>		
<p>CONJUNTO EVAPORADOR</p>		
<p>CALHA EVAPORADOR</p>		
<p>GAVETA LEGUMES</p>		
<p>SEPARADOR LEGUMES</p>		

PRATELEIRA PORTA FREEZER		
LÂMPADA LED		
CONJUNTO INTERFACE SPARSH		
CONTROLE ELETRÔNICO		

Gabinete embalado de reposição

O gabinete do produto antigo saiu de linha. Portanto, para atender os produtos antigos disponibilizamos os kits de gabinete que serão obrigatórios para fazer a instalação dos mesmos. Nesse kit, estão presentes os seguintes itens:

1. Capa frontal evaporador
2. Capa intermediária evaporador
3. Conjunto motor ventilador
4. Conjunto Evaporador para campo
5. Gaveta Legumes
6. Conjunto controle eletrônico Fides
7. Conjunto interface sparsh
8. Lâmpada LED
9. Controle eletrônico

- Versões de engenharia desde a 0.0 até a 7.0

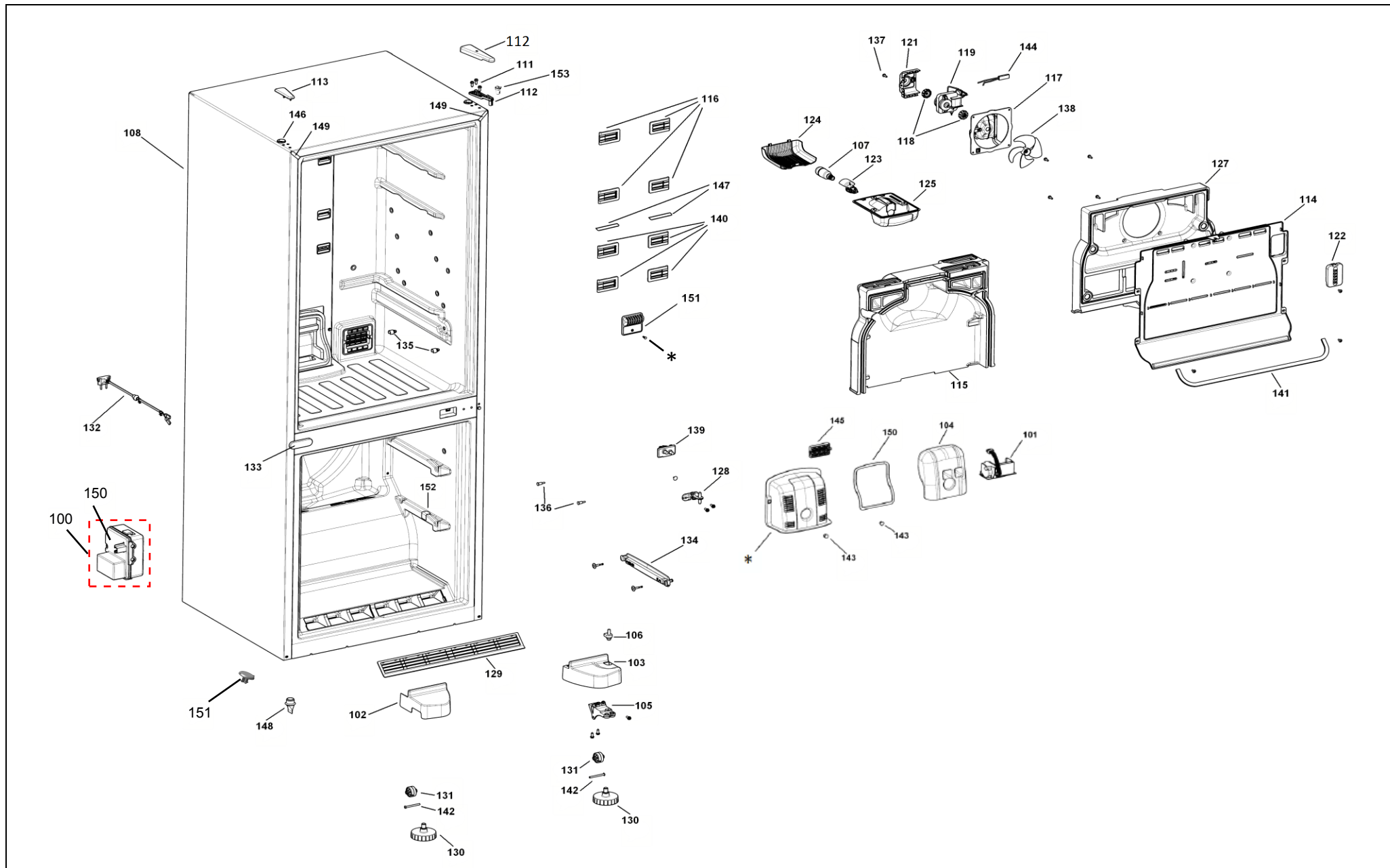

* Peça solicitada está cancelada e não há substituto. Neste caso, deverá ser aberto nova Atividade no canal GCC.

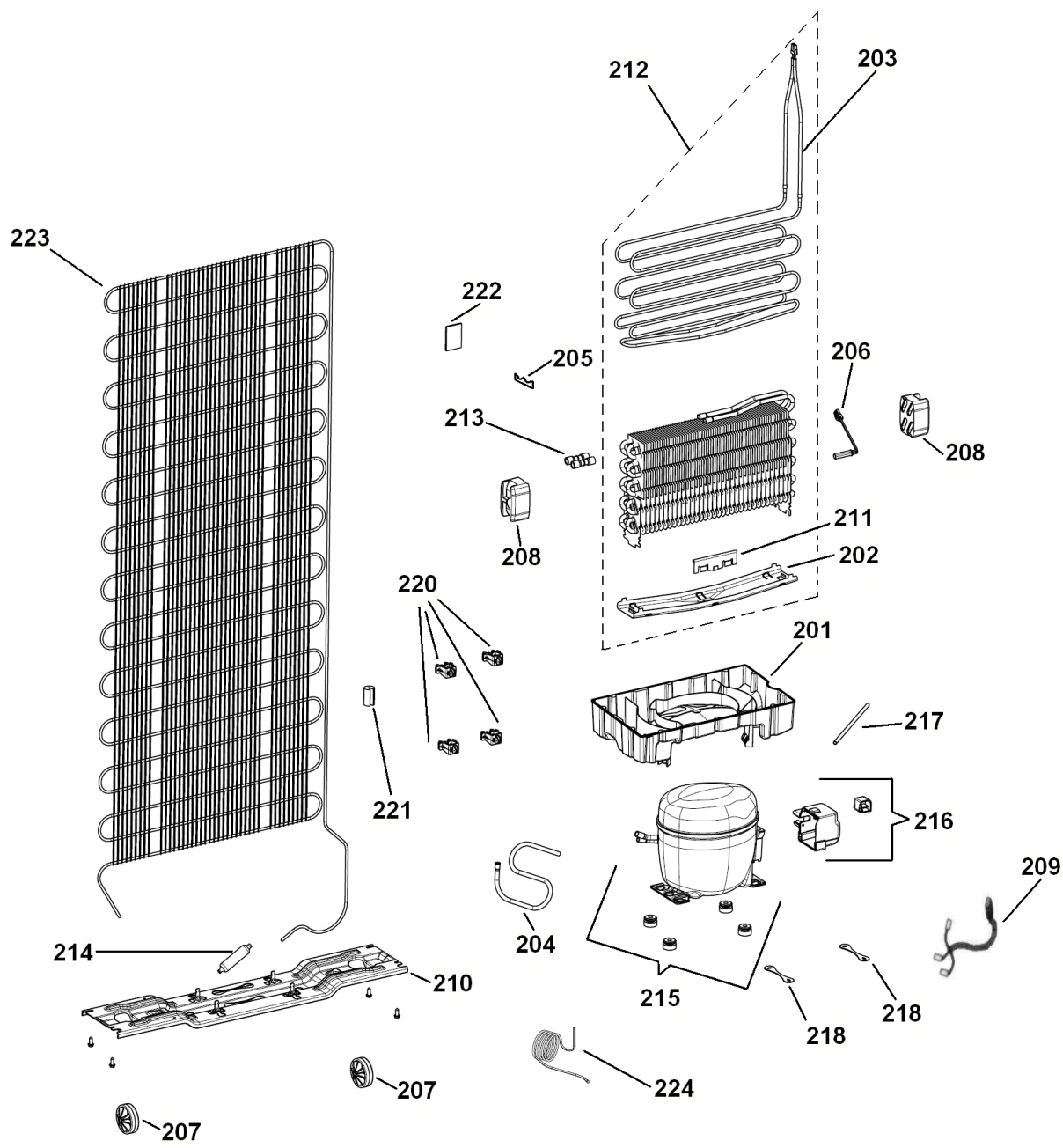

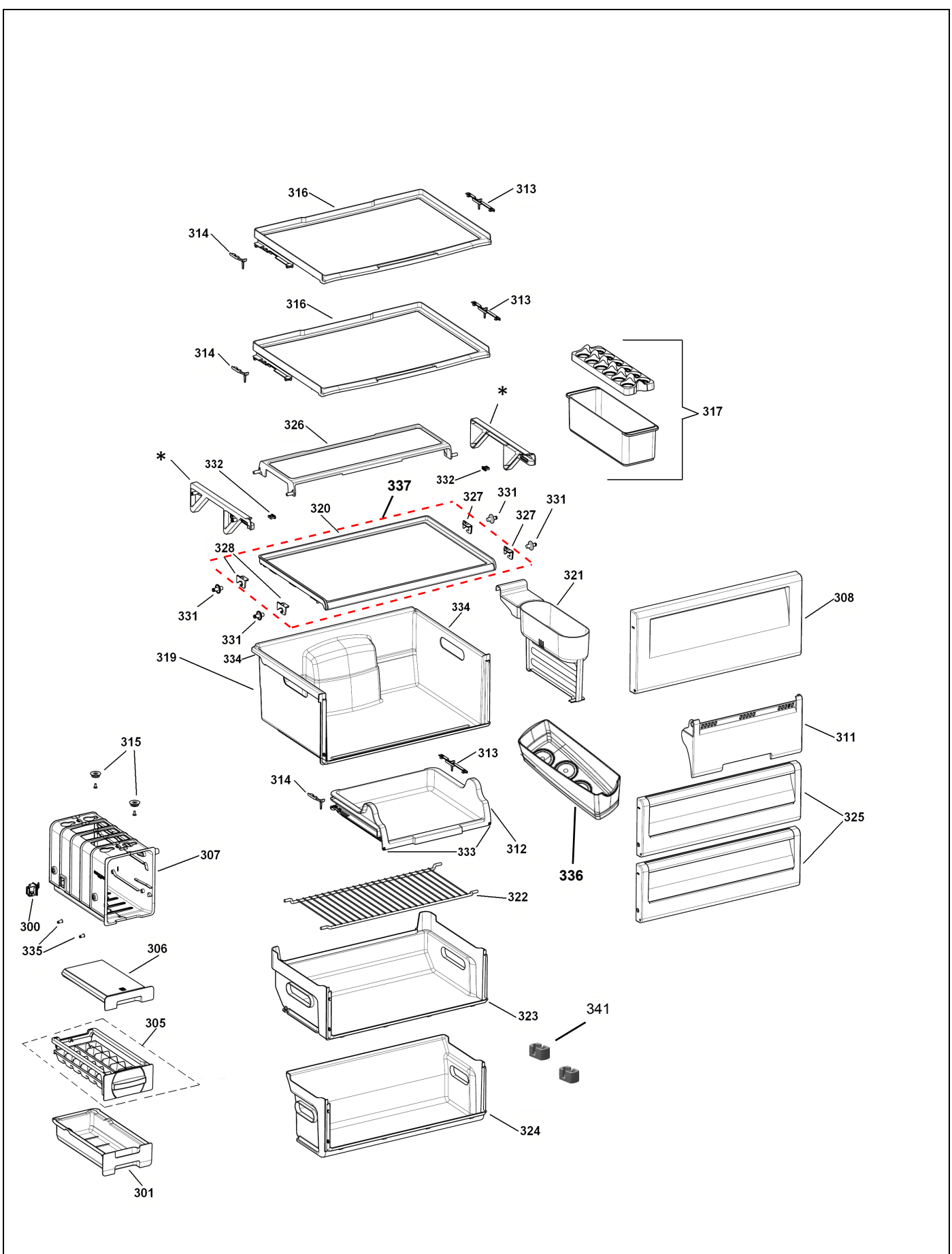

* Peça solicitada está cancelada e não há substituto. Neste caso, deverá ser aberto nova Atividade no canal GCC.

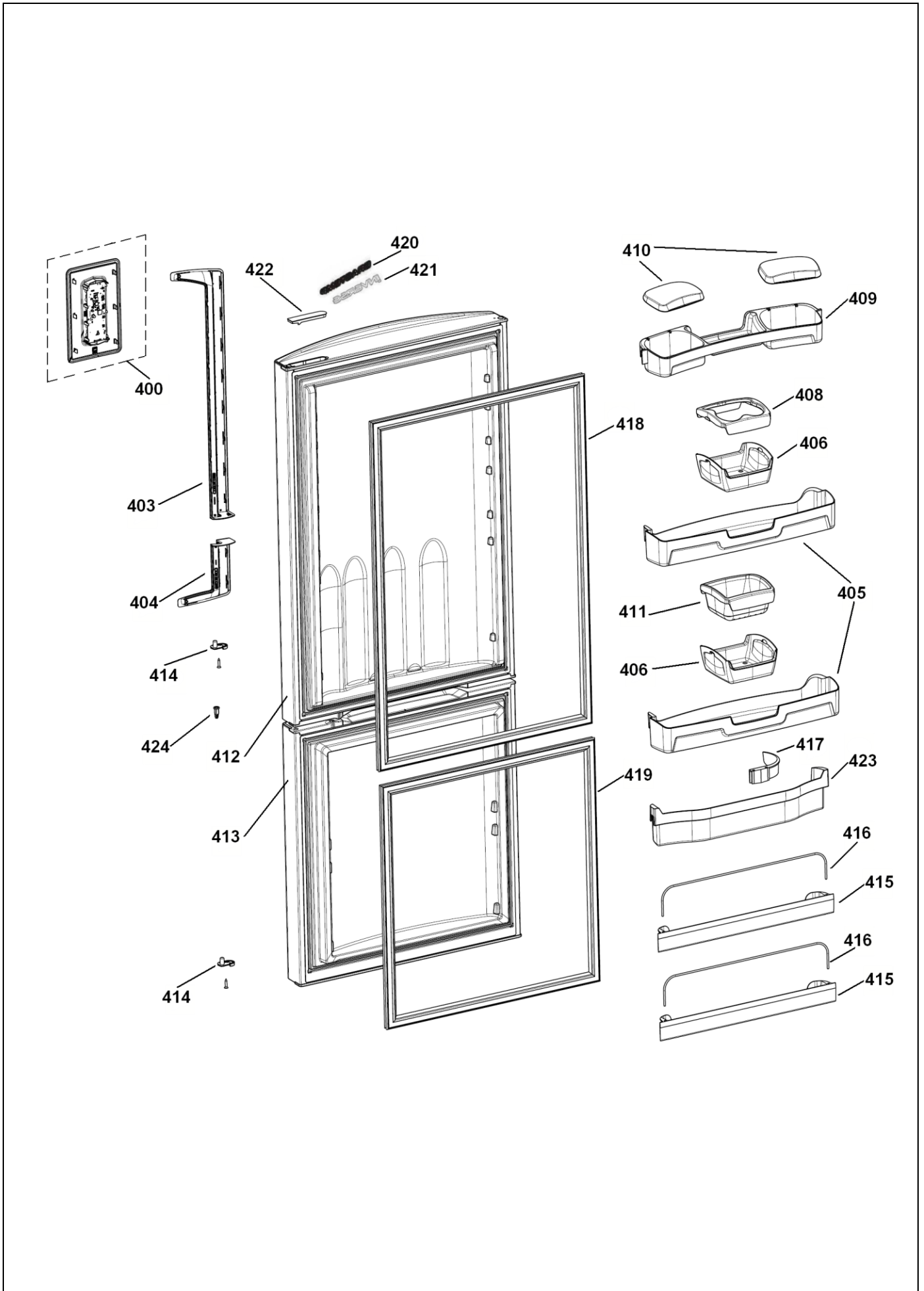

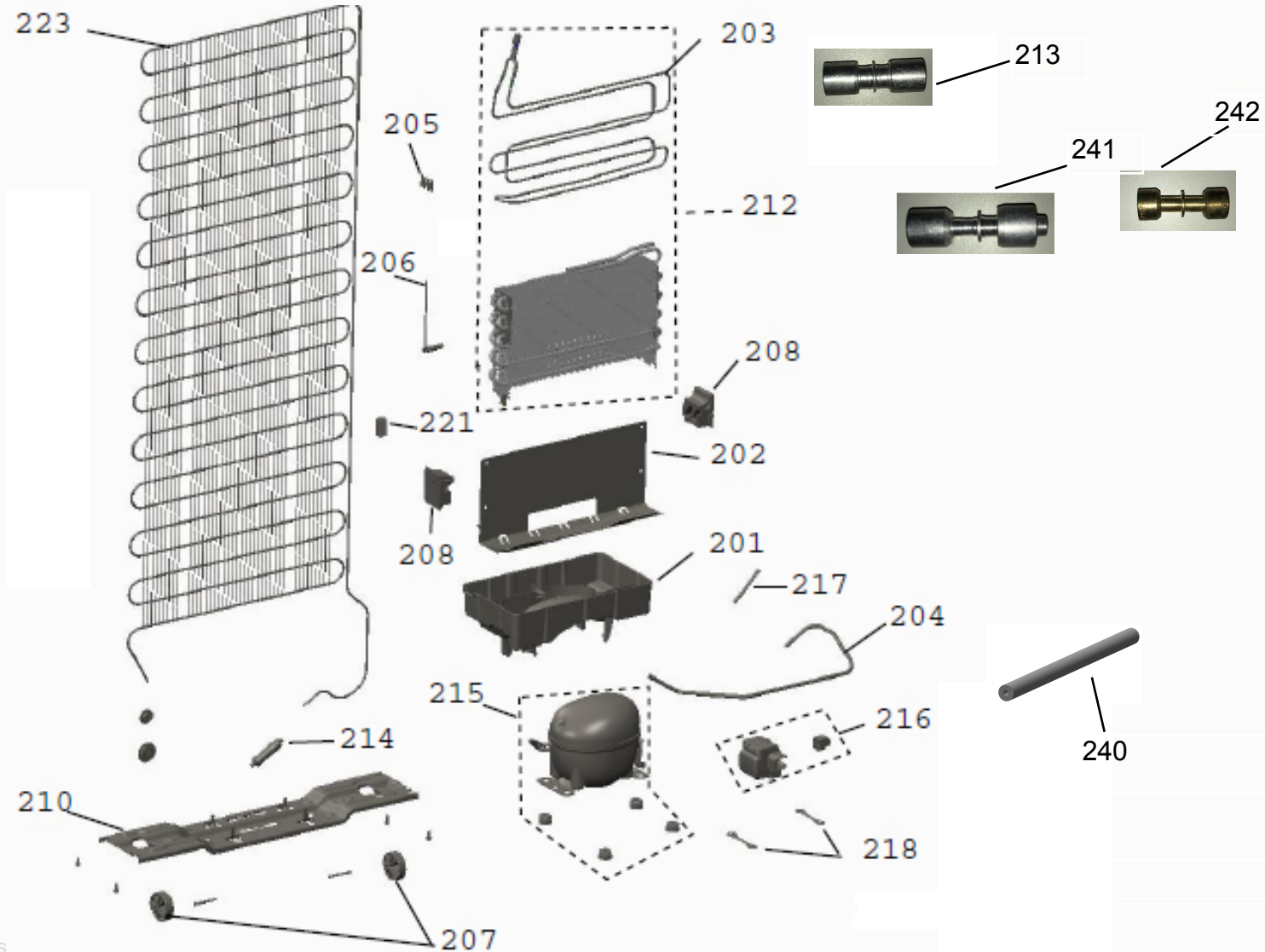

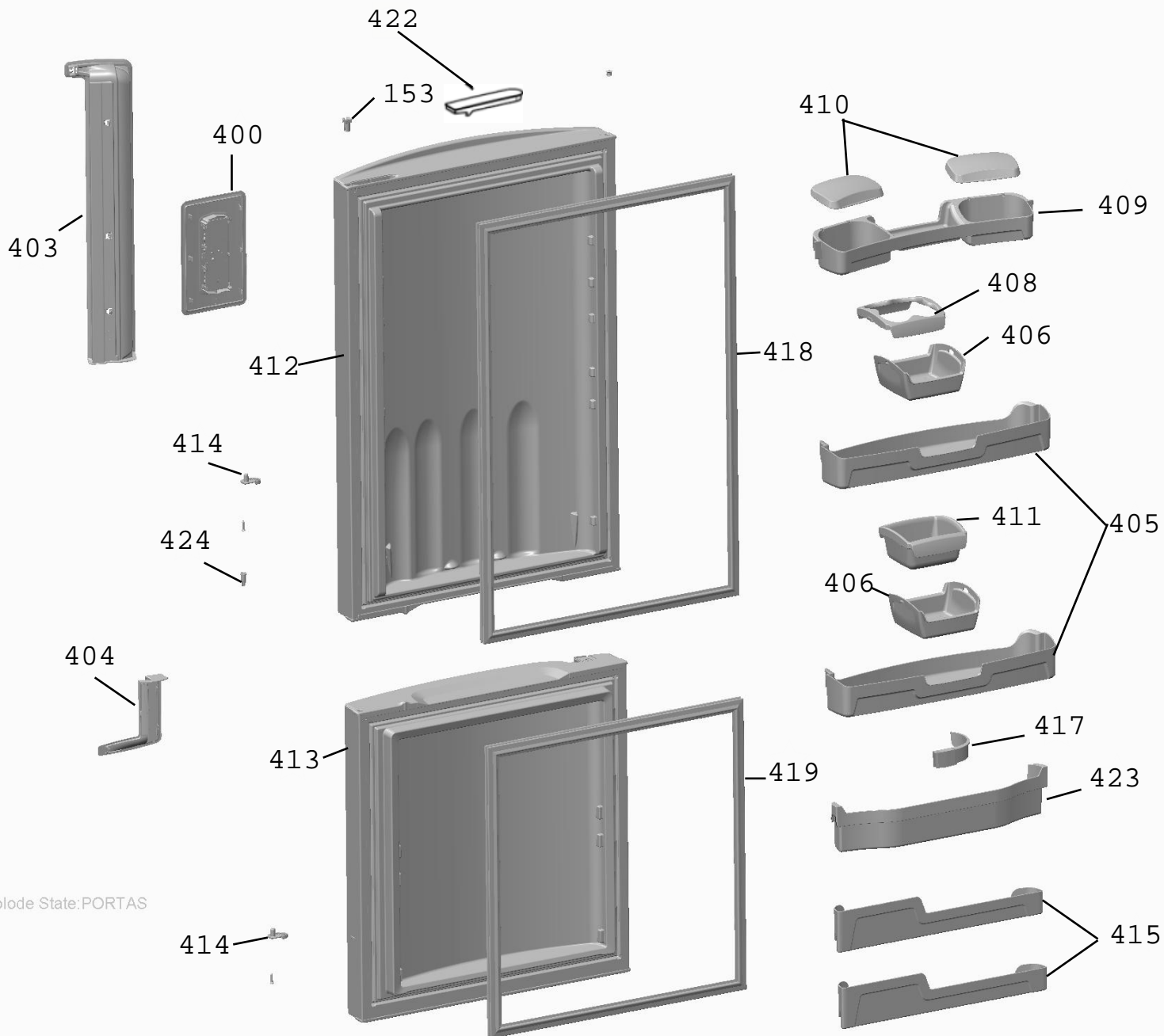



501



502



505



506

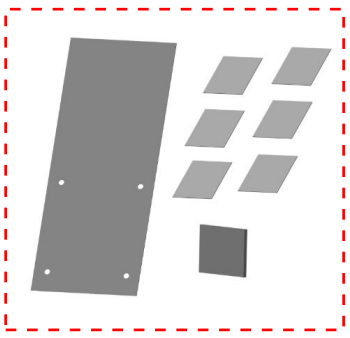

503



504



507



508



509



510

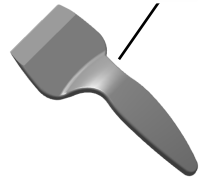

511

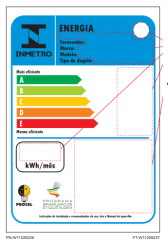

512

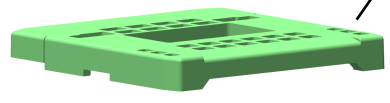

513

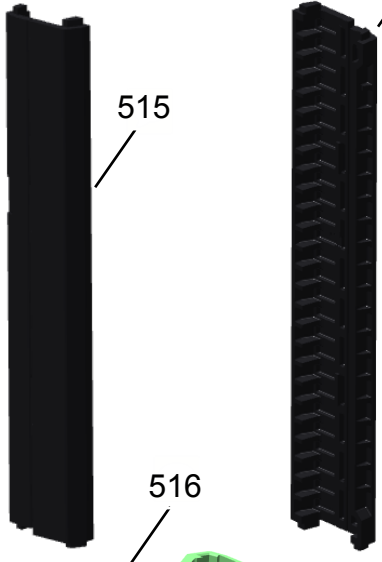

515

514

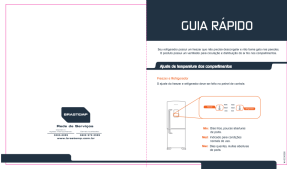

517

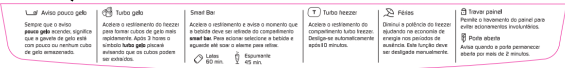

518



519



520



521



523



522

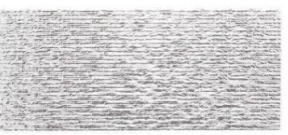

524



525



526

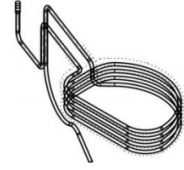

527



537



528



529



530



531



532



533



534



535



536