

BRASTEMP

CATÁLOGO DE PEÇAS

Refrigeradores Brastemp *Inverse Ative*

..

BRE50NJ

Revisão	Motivo	Páginas Alteradas	Elaborado Por	Revisado Por	Data
R0.0	Lançamento		Felipe P. Lordello	Rafaela S Matos	25/09/12
R1.0	Projeto Venturi	todas	Cassiano	Anderson Batista	15/02/15

COMUNICADO IMPORTANTE

Novas versões de produto

A partir de 21 de janeiro de 2014, iniciamos a produção das novas versões de engenharia desse produto.







PRODUTOS ANTIGOS



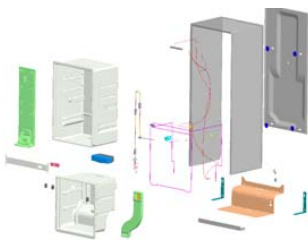
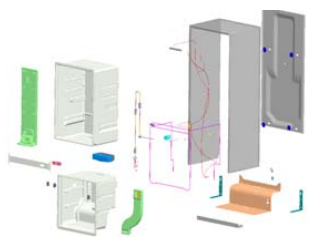

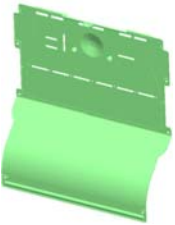

- Versões de engenharia desde a 0.0 até a **3.0**

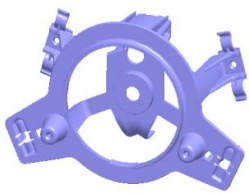

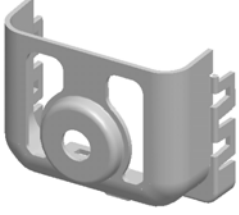

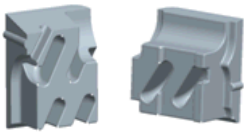
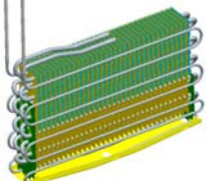
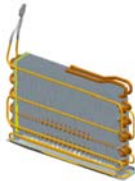
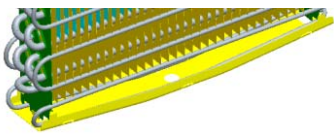
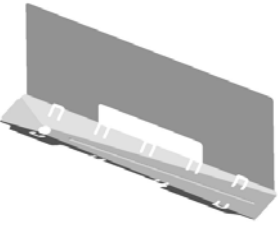
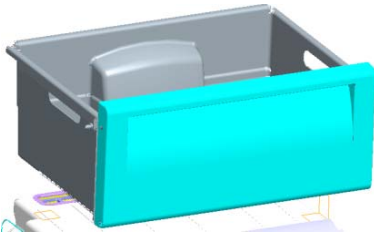
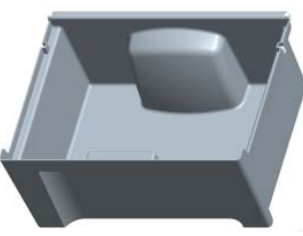

PRODUTOS NOVOS

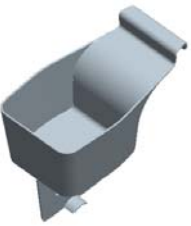
- Versões de engenharia iniciando da **4.0** em diante

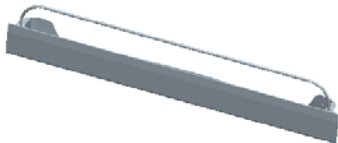
O que alterou nos produtos novos?

Descrição	Antigo	Novo
GABINETE EMBALADO		
CAPA FRONTAL EVAPORADOR		
CAPA INTERMEDIÁRIA EVAPORADOR		
SUPORTE MOTOR VENTILADOR		

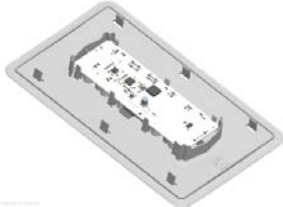
<p>TAMPA SUPORTE MOTOR VENTILADOR</p>		
<p>MOTOR VENTILADOR</p>		
<p>CALÇO DO EVAPORADOR</p>		
<p>CONJUNTO EVAPORADOR</p>		
<p>CALHA EVAPORADOR</p>		
<p>GAVETA LEGUMES</p>		
<p>SEPARADOR LEGUMES</p>		

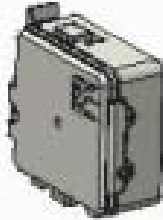
PRATELEIRA PORTA FREEZER		
LÂMPADA LED		
CONJUNTO INTERFACE SPARSH		
CONTROLE ELETRÔNICO		

Gabinete embalado de reposição

O gabinete do produto antigo saiu de linha. Portanto, para atender os produtos antigos disponibilizamos os kits de gabinete que serão obrigatórios para fazer a instalação dos mesmos. Nesse kit, estão presentes os seguintes itens:

1. Capa frontal evaporador
2. Capa intermediária evaporador
3. Conjunto motor ventilador
4. Conjunto Evaporador para campo
5. Gaveta Legumes
6. Conjunto controle eletrônico Fides
7. Conjunto interface sparsh
8. Lâmpada LED
9. Controle eletrônico

Peças personalizáveis



Atenção! Antes de pedir as peças citadas abaixo, certifique-se que a peça do cliente corresponde à cor/serigrafia correspondente citada na descrição.

CORES



SERIGRAFIA

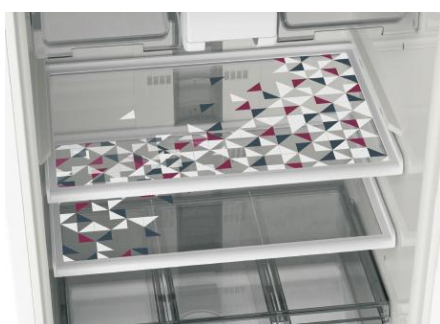

Prateleiras de vidro
(somente nos modelos BRK/BRM/BRW)



Porta sorveteira/fruteira
(somente nos modelos BRK/BRM/BRW)

PEÇAS PERSONALIZADAS

Ref.	Descrição
102	RODAPE ESQUERDO (cor)
103	RODAPE DIREITO (cor)
108	GABINETE EMBALADO (cor)
110	CAPA DOBRADIÇA SUPERIOR (cor)
113	TAMPÃO FUROS DOBRADIÇA (cor)
133	COMPLEMENTO TRAVESSA INTERM. (cor)
139	INTERRUPTOR (cor)
149	ACABAMENTO CANTO (cor)
320	PRATELEIRA DE VIDRO (com ou sem serigrafia)
400	CONJUNTO INTERFACE SPARSH (cor)
403	PUXADOR COMPLEMENTO REFRIG (cor)
404	PUXADOR COMPLEMENTO FREEZER (cor)
412	PORTA EMB REFRIGERADOR (cor 1) (BASE PUXADOR (cor2))
413	PORTA EMB FREEZER (cor 1) (BASE PUXADOR (cor2))
425	EMBLEMA YOU (cor)

- Versões de engenharia desde a 0.0 até a **3.0**

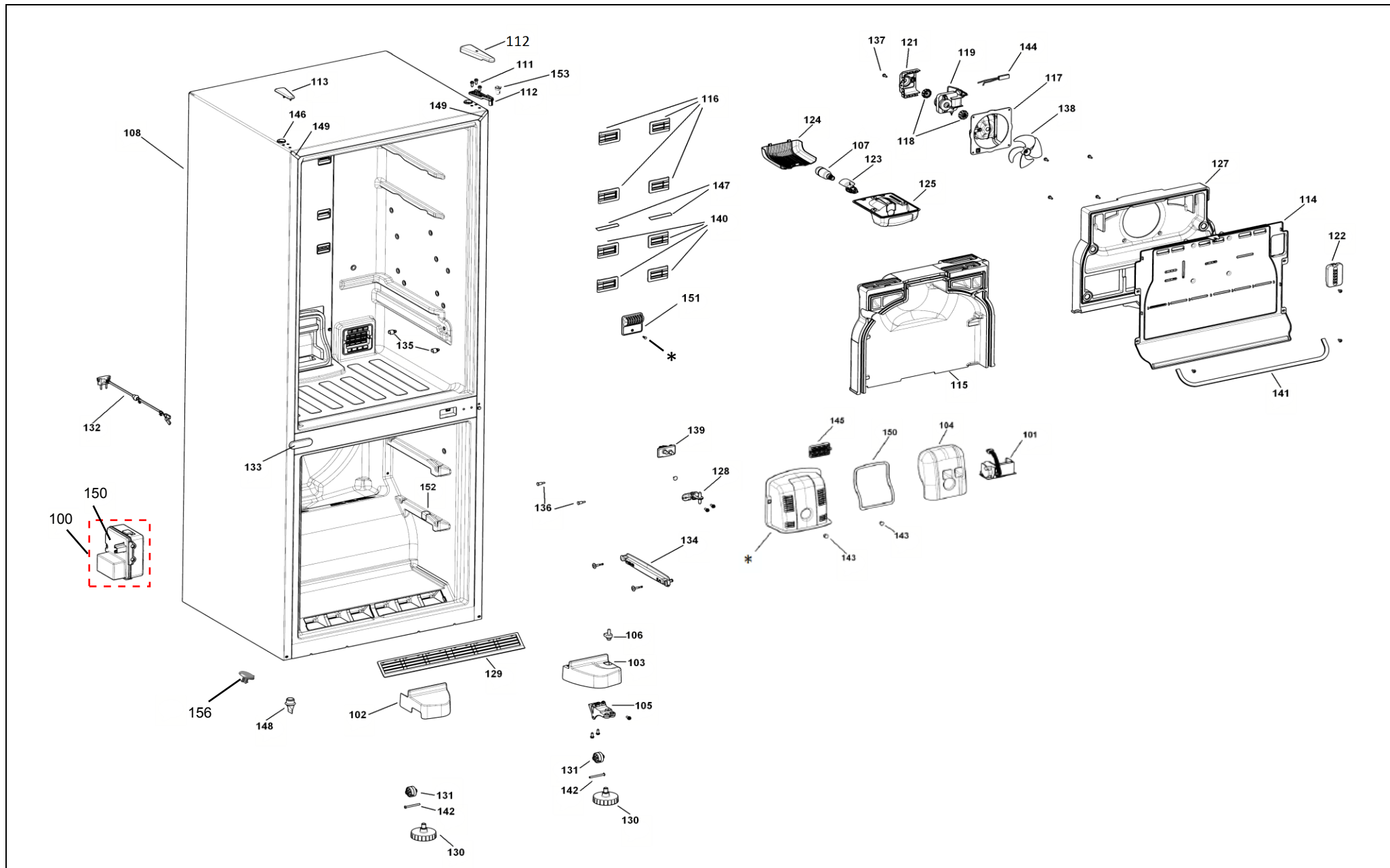

* Peça solicitada está cancelada e não há substituto. Neste caso, deverá ser aberto nova Atividade no canal GCC.

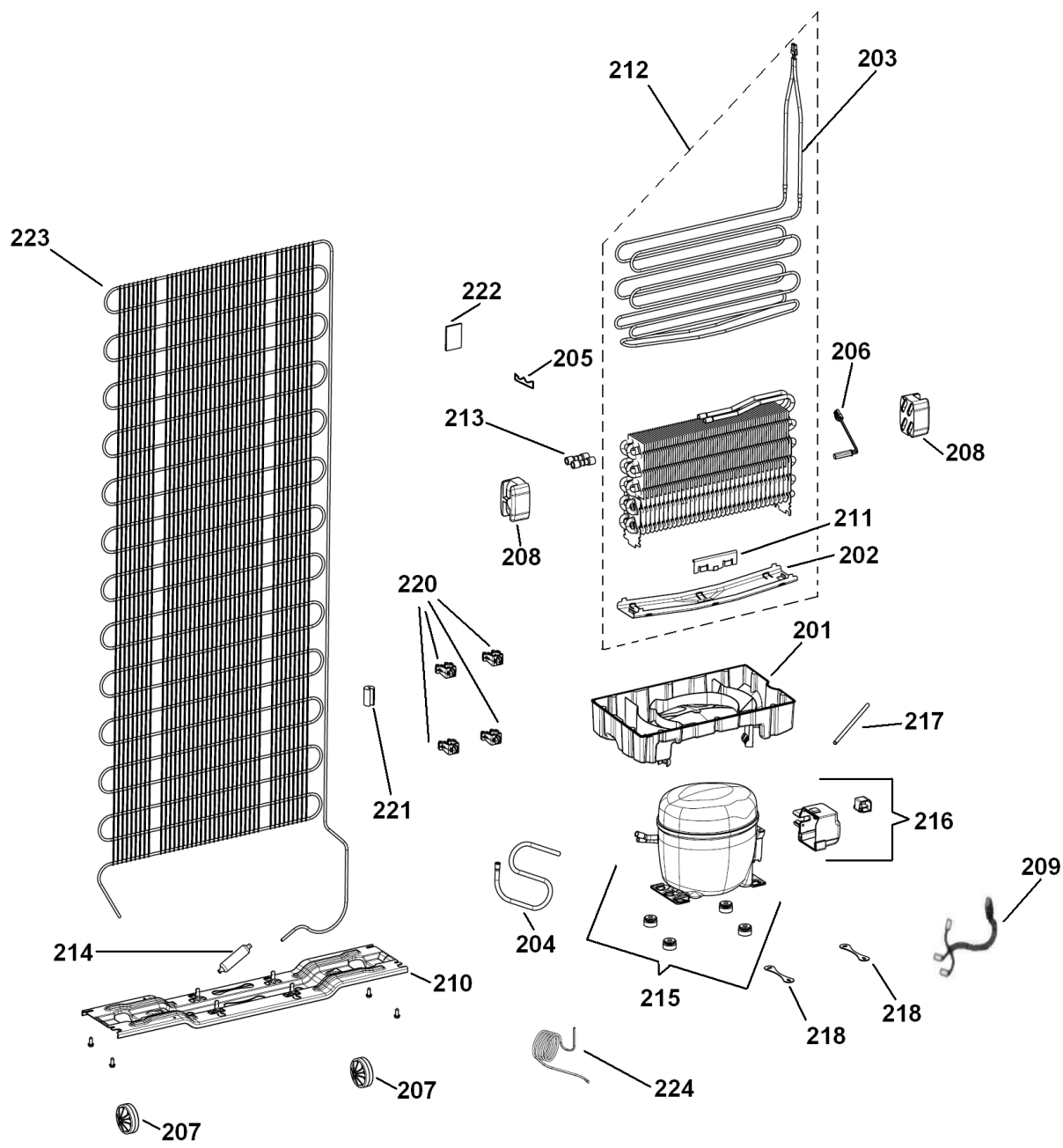

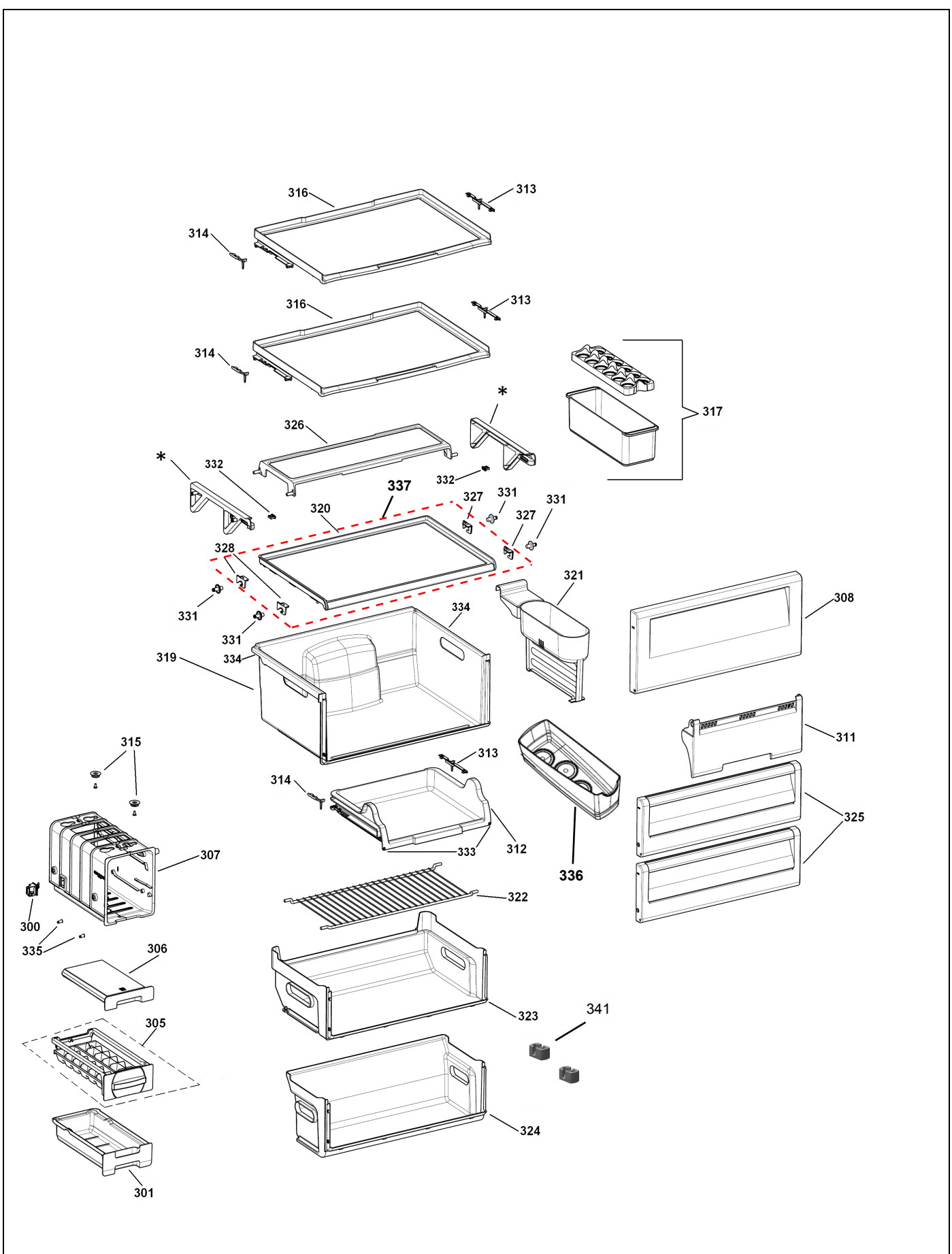

* Peça solicitada está cancelada e não há substituto. Neste caso, deverá ser aberto nova Atividade no canal GCC.

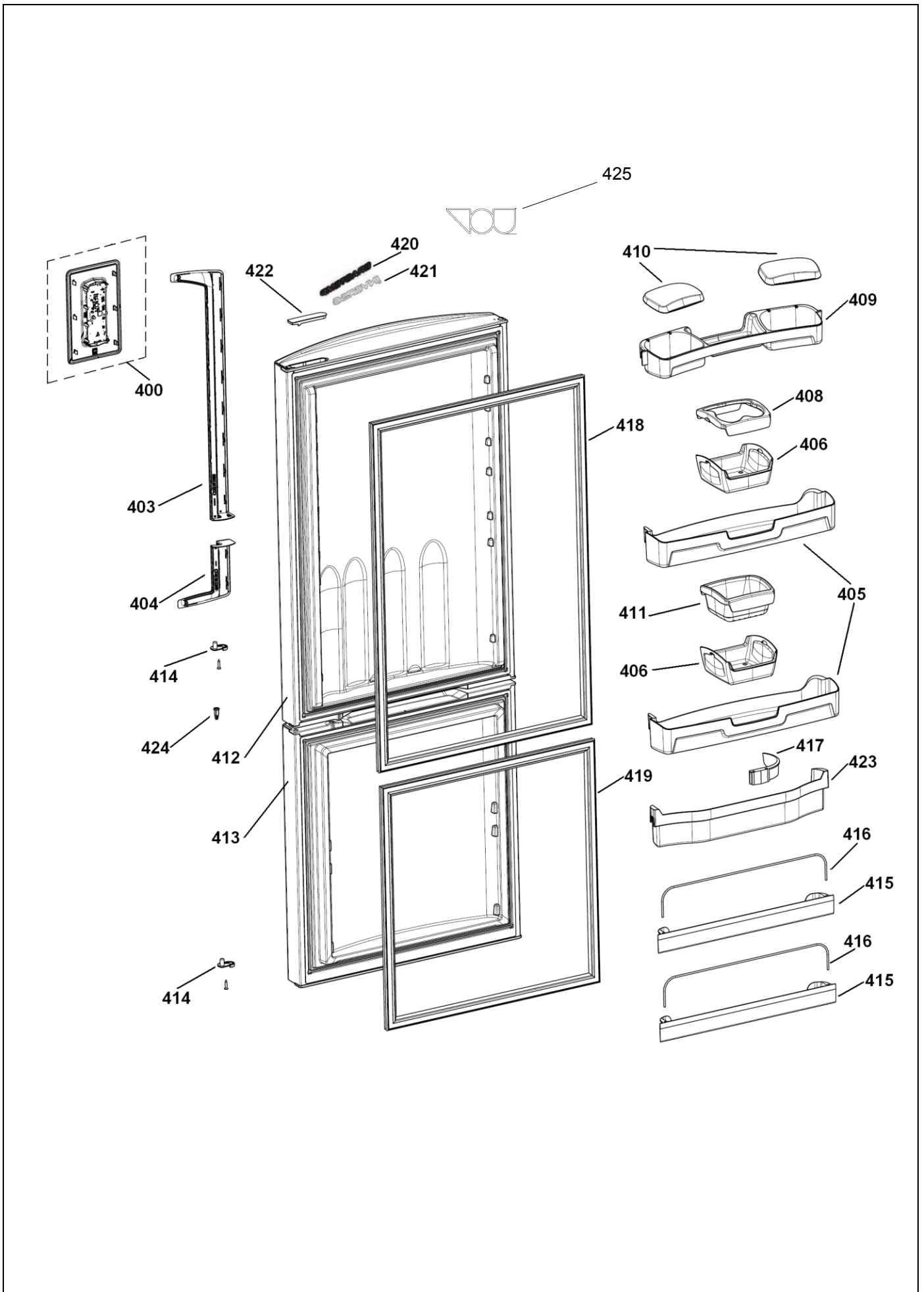

- Versões de engenharia iniciando da **4.0** em diante

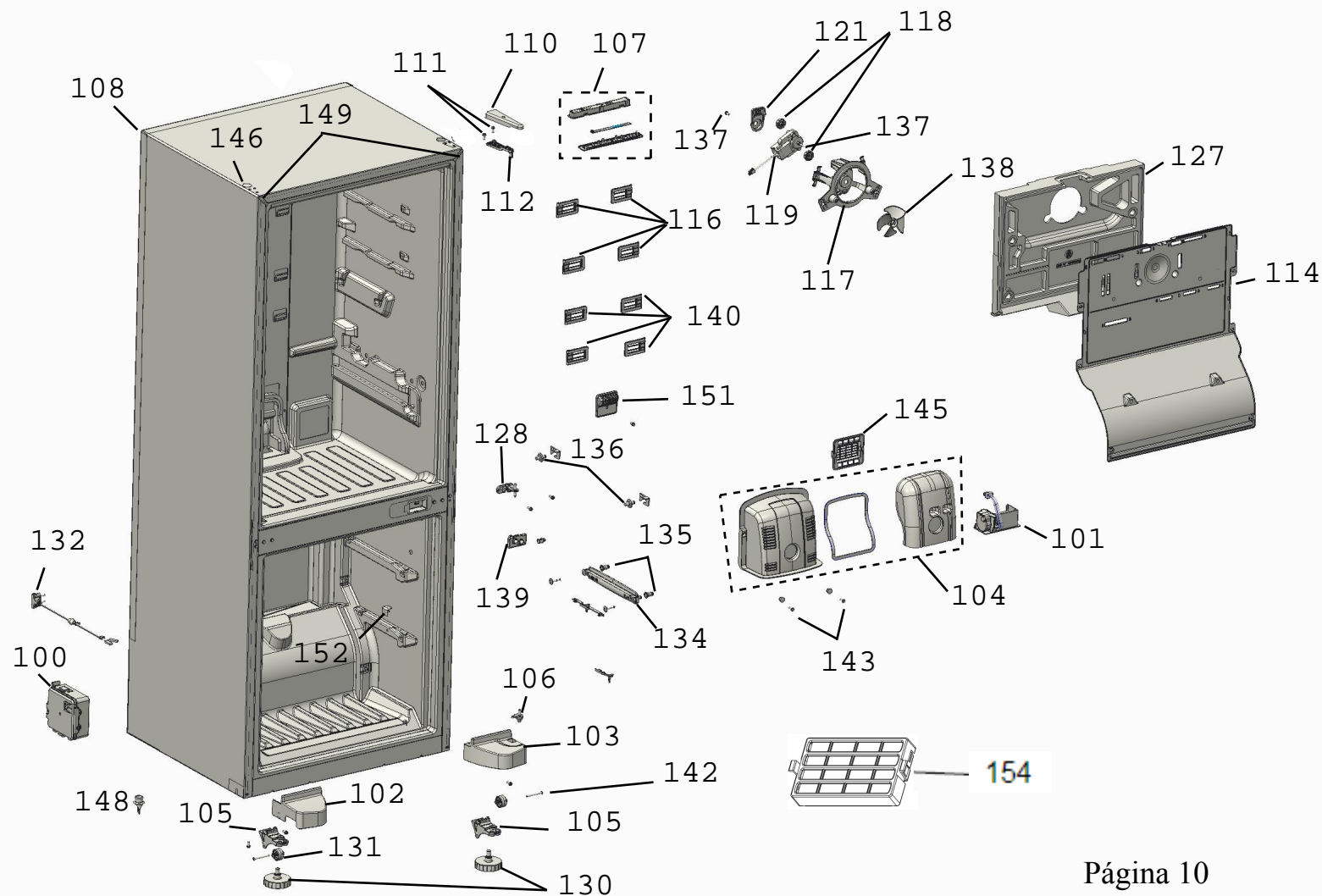

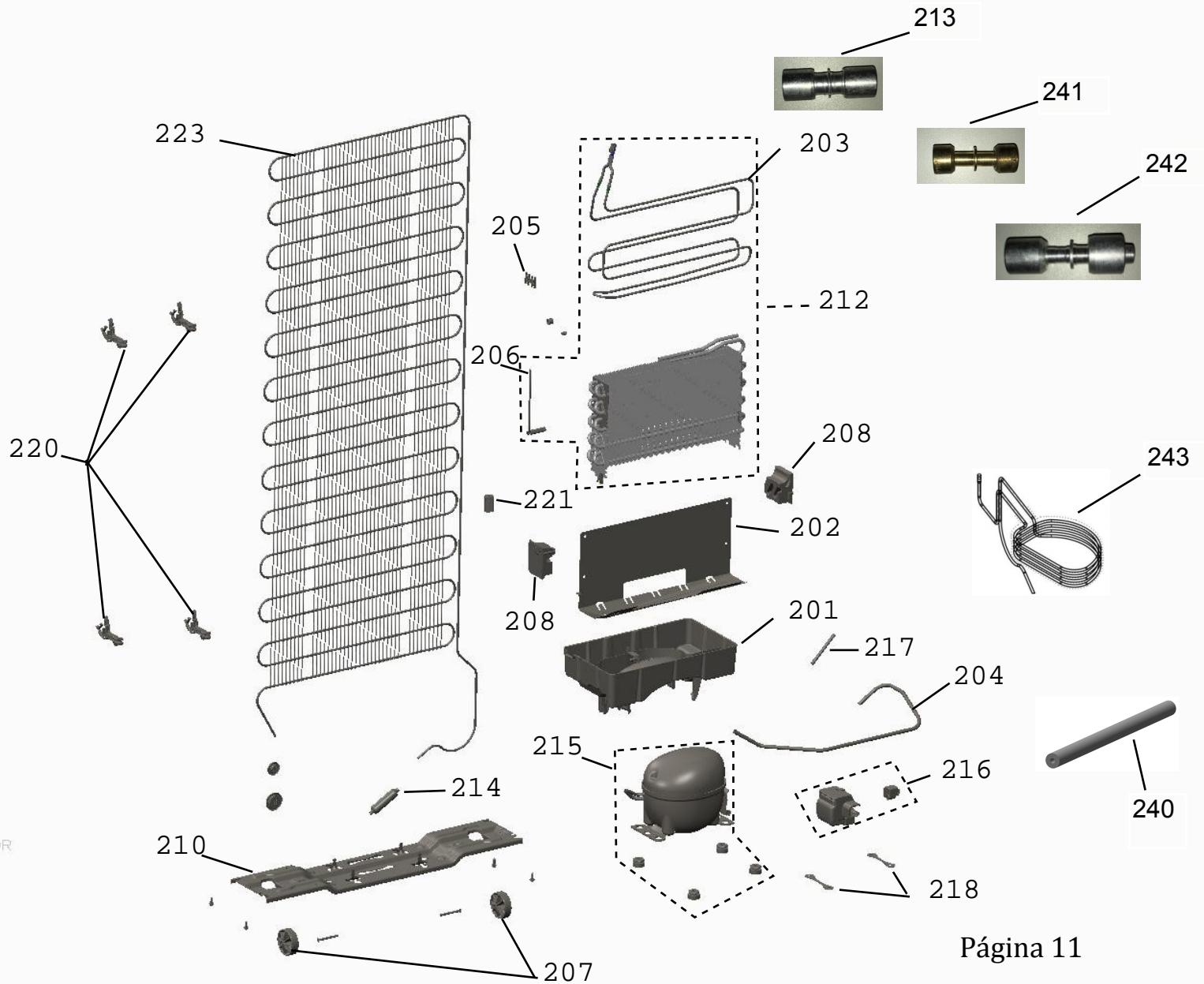

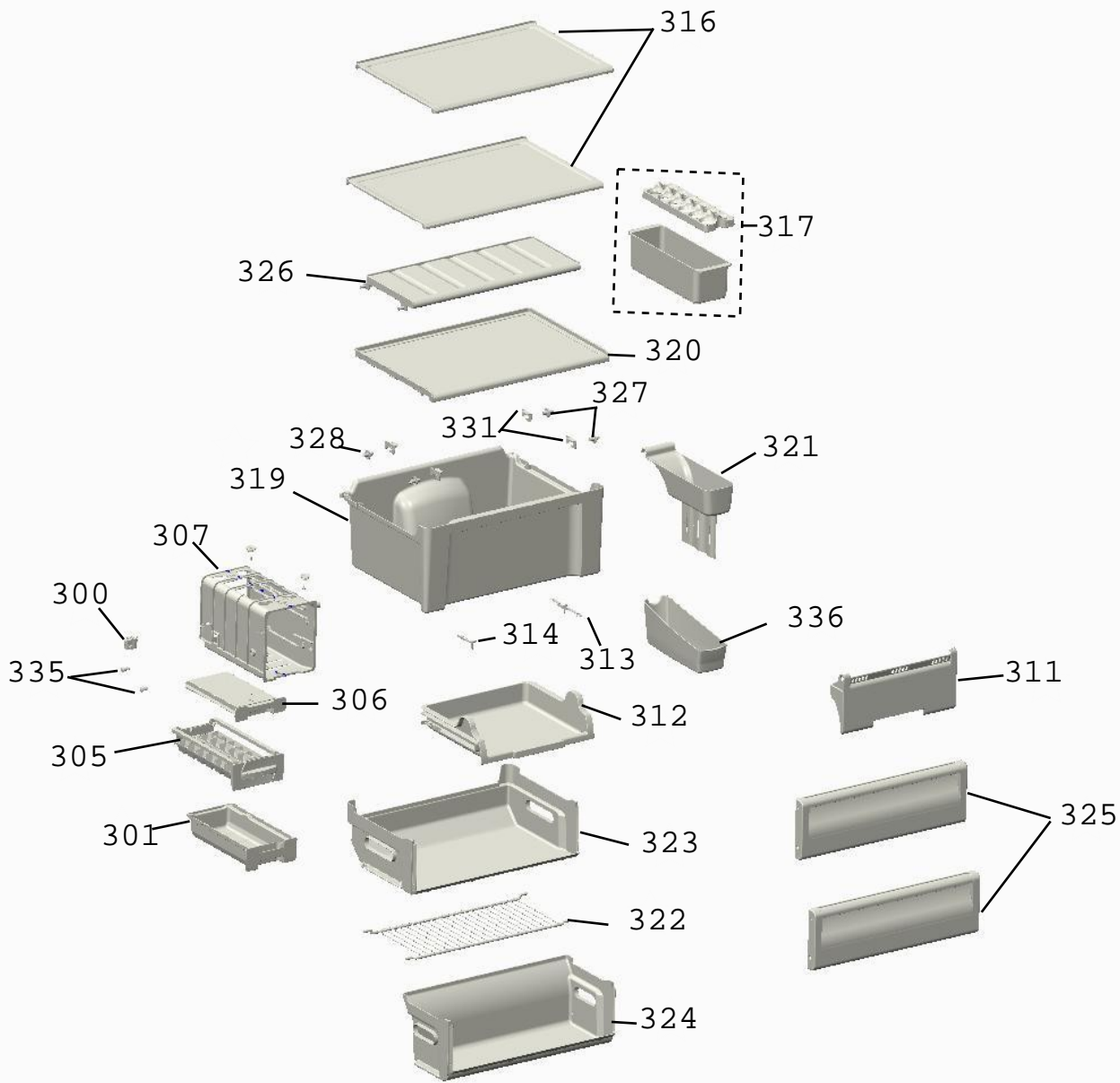

ATURES

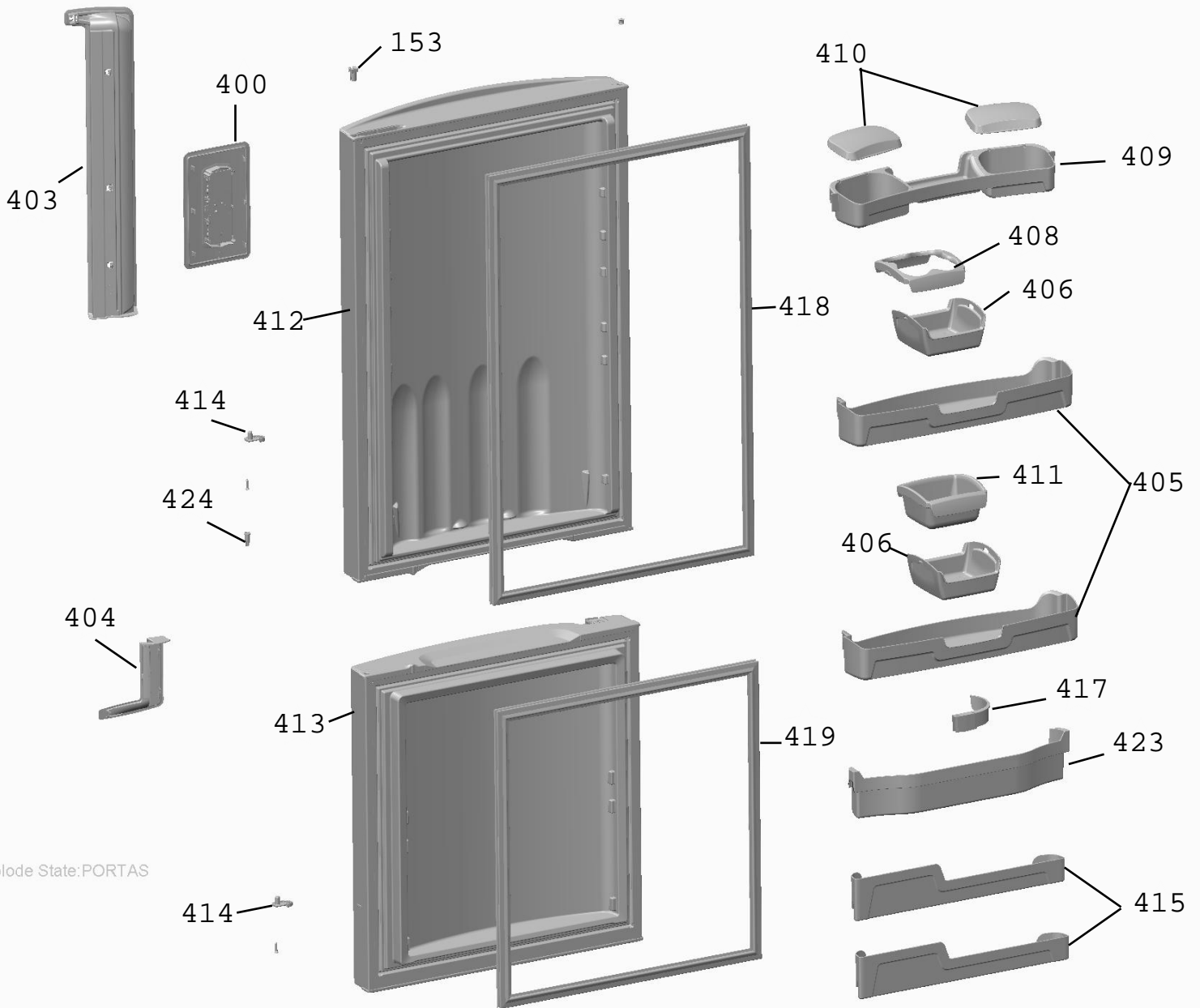



501

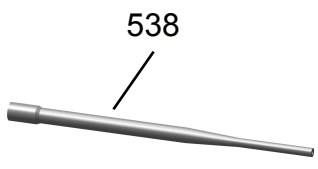

538

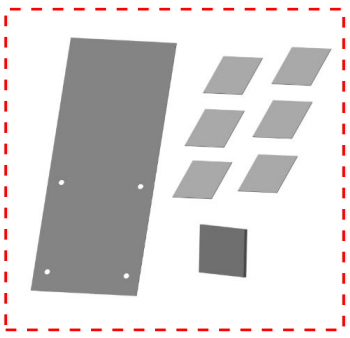

503



504

539

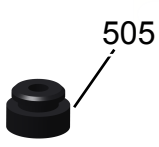

505

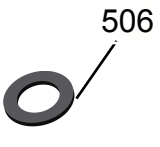

506



507



508

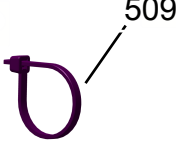

509



510

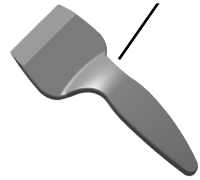

511

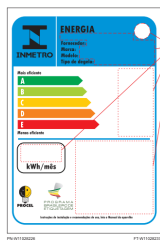

512

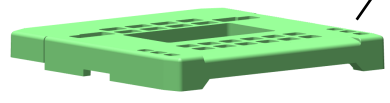

513



517



518

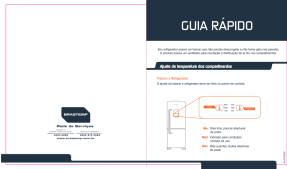

519

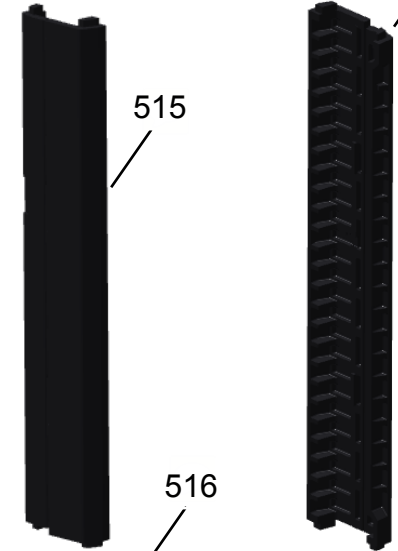
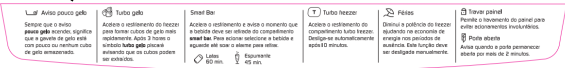

515



514

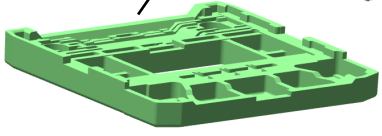

516

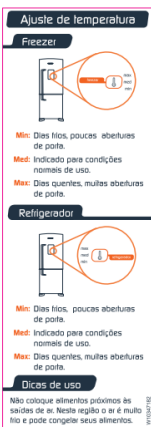

519



520



521



523



522



525

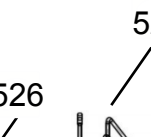

527

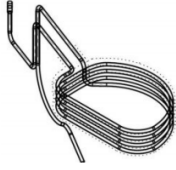

537

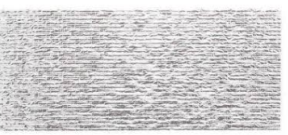

524



528



529



530



531



532



533



534



535



540



536