

**BRASTEMP**

# **CATÁLOGO DE PEÇAS**

## **Refrigeradores Brastemp Inverse *Ative***

### **BRE50NB**

<b>Revisão</b>	<b>Motivo</b>	<b>Páginas Alteradas</b>	<b>Elaborado Por</b>	<b>Revisado Por</b>	<b>Data</b>
R0.0	Lançamento		Felipe P. Lordello	Rafaela S Matos	25/09/12
R1.0	Projeto Venturi	todas	Cassiano	Anderson Batista	15/02/15

# COMUNICADO IMPORTANTE

## Novas versões de produto

A partir de 21 de janeiro de 2014, iniciamos a produção das novas versões de engenharia desse produto.







### PRODUTOS ANTIGOS



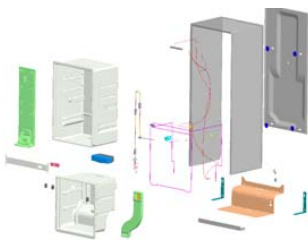
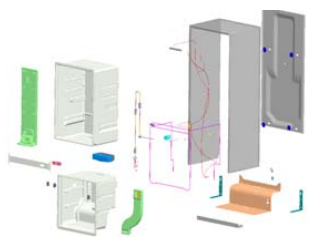

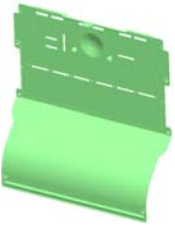

- Versões de engenharia desde a 0.0 até a **8.0**

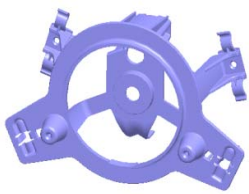

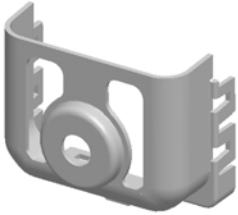

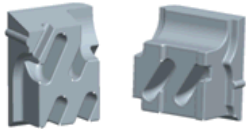
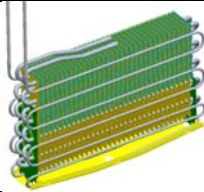
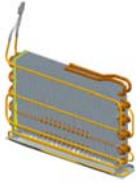
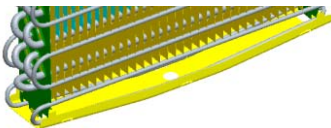
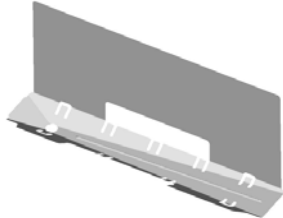
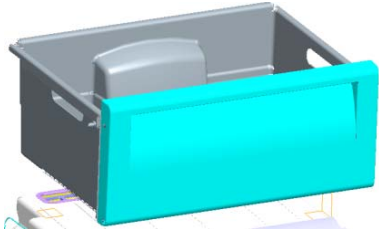
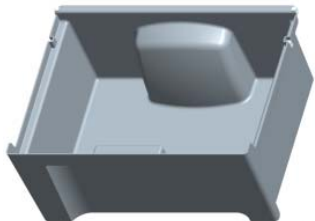

### PRODUTOS NOVOS

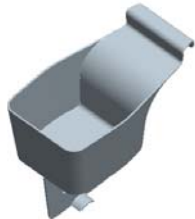
- Versões de engenharia iniciando da **9.0** em diante

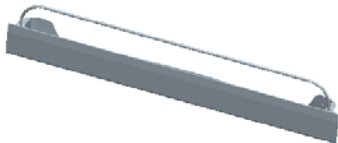
## O que alterou nos produtos novos?

Descrição	Antigo	Novo
GABINETE EMBALADO		
CAPA FRONTAL EVAPORADOR		
CAPA INTERMEDIÁRIA EVAPORADOR		
SUPORTE MOTOR VENTILADOR		

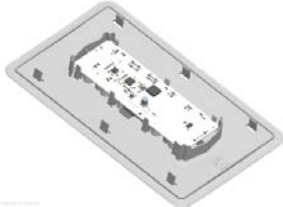
<p>TAMPA SUPORTE MOTOR VENTILADOR</p>		
<p>MOTOR VENTILADOR</p>		
<p>CALÇO DO EVAPORADOR</p>		
<p>CONJUNTO EVAPORADOR</p>		
<p>CALHA EVAPORADOR</p>		
<p>GAVETA LEGUMES</p>		
<p>SEPARADOR LEGUMES</p>		

PRATELEIRA PORTA FREEZER		
LÂMPADA LED		
CONJUNTO INTERFACE SPARSH		
CONTROLE ELETRÔNICO		

## Gabinete embalado de reposição

O gabinete do produto antigo saiu de linha. Portanto, para atender os produtos antigos disponibilizamos os kits de gabinete que serão obrigatórios para fazer a instalação dos mesmos. Nesse kit, estão presentes os seguintes itens:

1. Capa frontal evaporador
2. Capa intermediária evaporador
3. Conjunto motor ventilador
4. Conjunto Evaporador para campo
5. Gaveta Legumes
6. Conjunto controle eletrônico Fides
7. Conjunto interface sparsh
8. Lâmpada LED
9. Controle eletrônico

- Versões de engenharia desde a 0.0 até a **8.0**

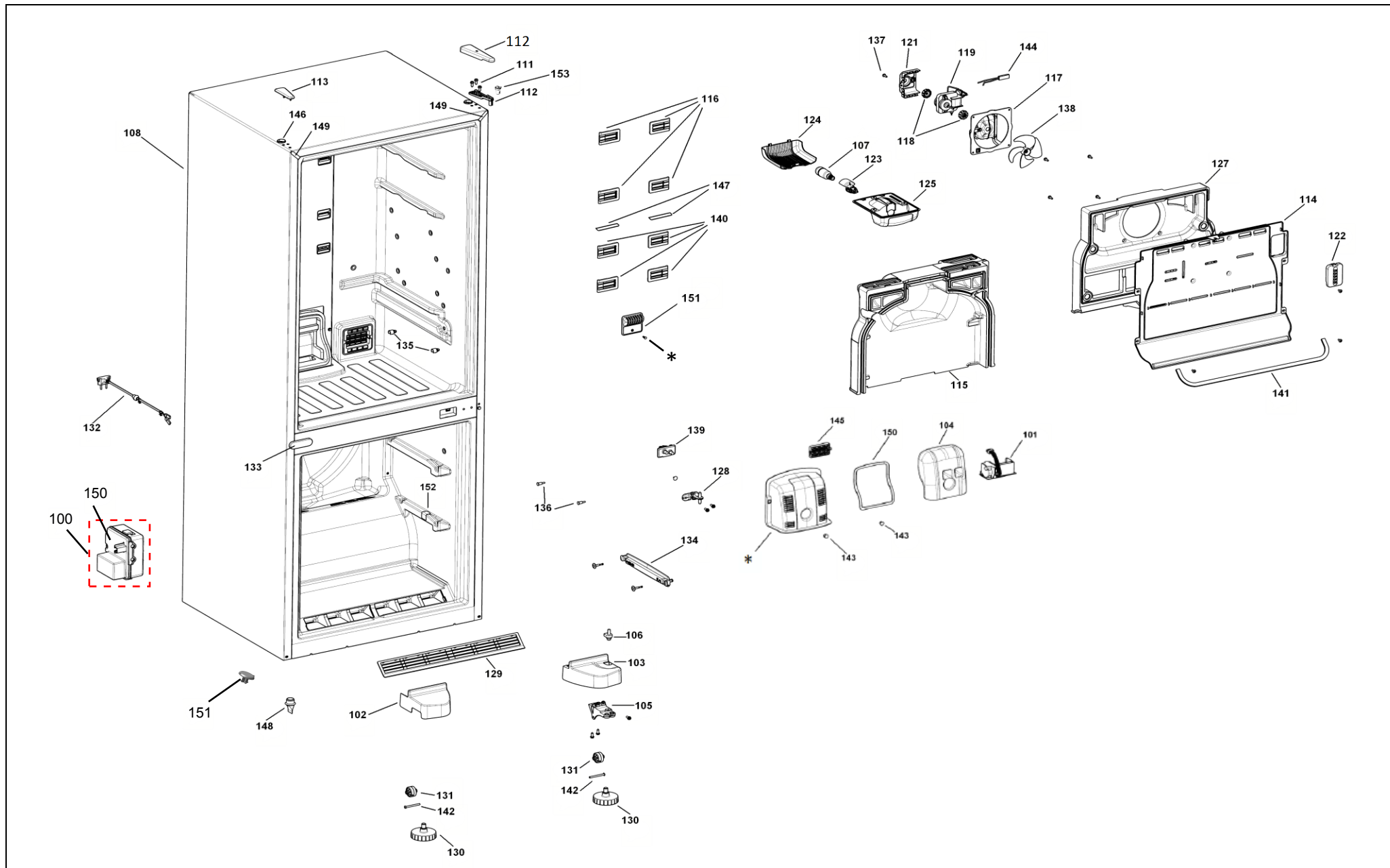

\* Peça solicitada está cancelada e não há substituto. Neste caso, deverá ser aberto nova Atividade no canal GCC.

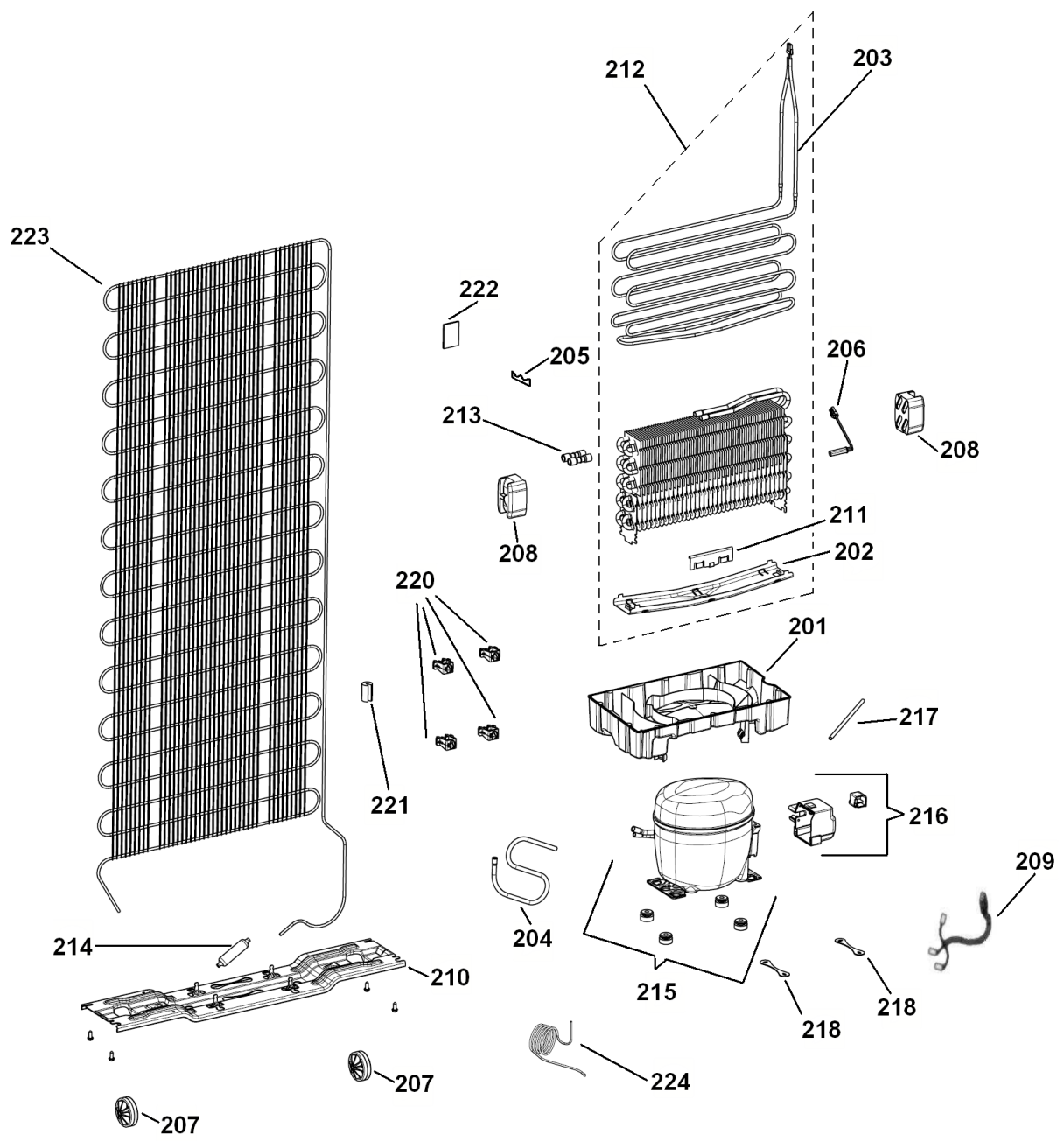

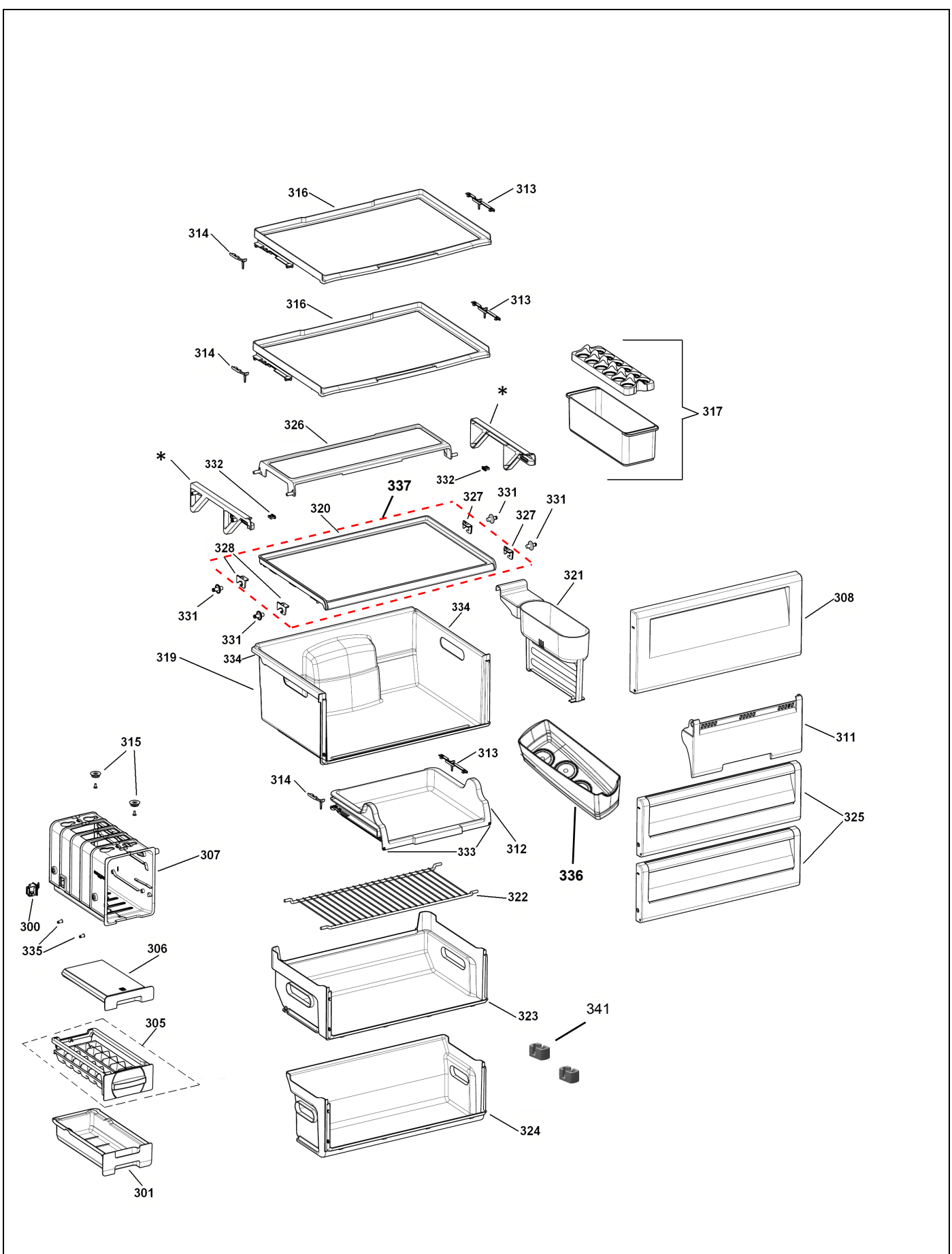

\* Peça solicitada está cancelada e não há substituto. Neste caso, deverá ser aberto nova Atividade no canal GCC.

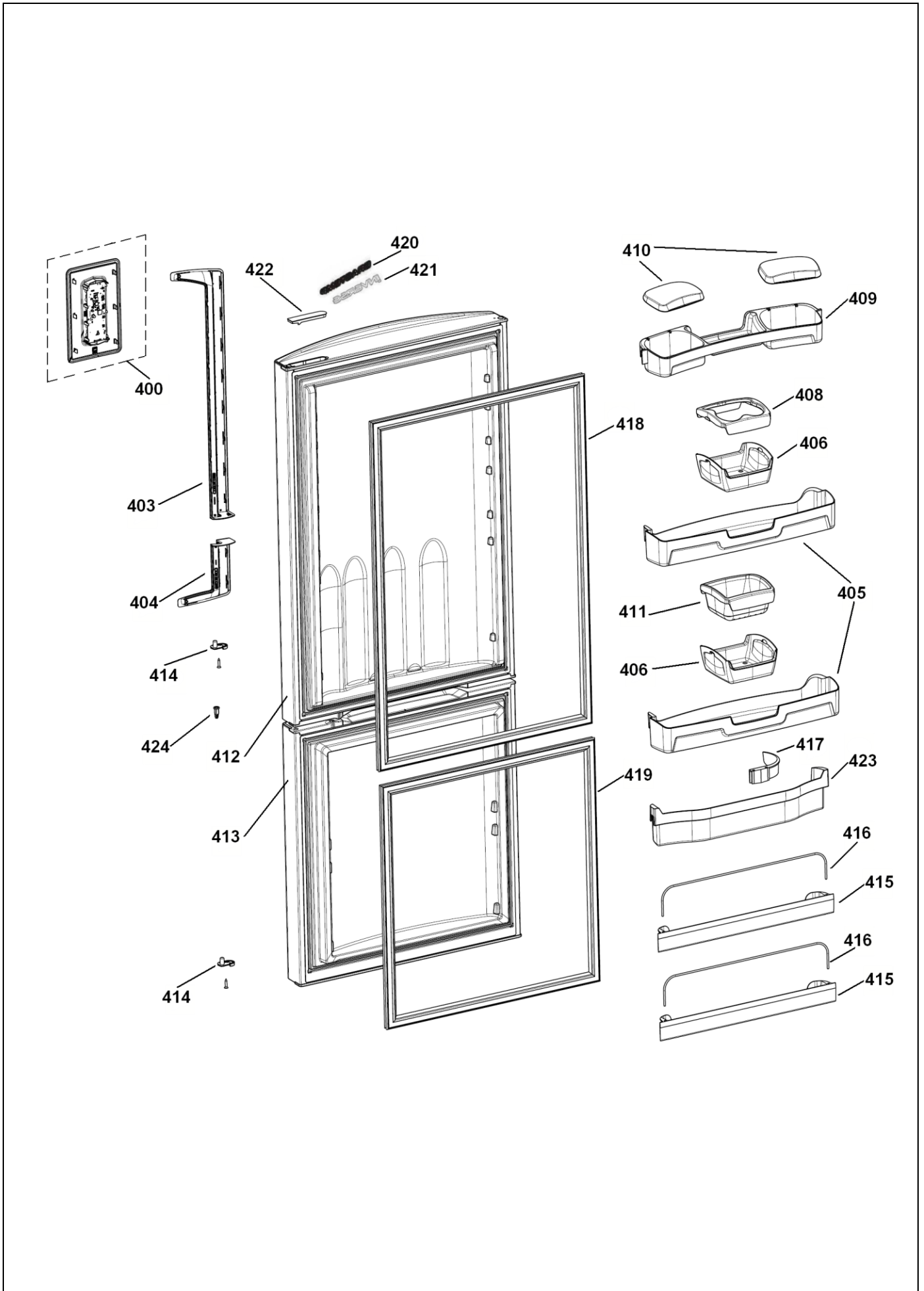



- Versões de engenharia iniciando da **9.0** em diante

