

BRASTEMP

CATÁLOGO DE PEÇAS

Refrigeradores Brastemp Inverse Maxi

BRE80AR

Revisão	Motivo	Páginas Alteradas	Elaborado Por	Revisado Por	Data
R0.0	Lançamento		Felipe P. Lordello	Rafaela S Matos	08/08/12

Marca	Linha	Características	Modelo	Versão	Cor	Tensão	Mercado
1º	2º	3º	4º	5º	6º	7º	8º
B	R	E	80	A	B	B	NA

1º Dígito	<u>Marca</u>	B	Brastemp
2º Dígito	<u>Linha</u>	R	Refrigerador por compressão
3º Dígito	<u>Característica</u>	E	2 portas, congelador inferior, degelo automático (Frost Free) e controle eletrônico na porta
		V	2 portas, congelador inferior, degelo automático (Frost Free) e controle eletrônico touch na porta e home bar
4º Dígito	<u>Modelo</u>	80	80 cm de largura
5º Dígito	<u>Versão</u>	A	Primeira Versão
6º Dígito	<u>Cor</u>	B	Branco
		R	Inox
7º Dígito	<u>Tensão</u>	A	127V
		B	220V
8º Dígito	<u>Mercado</u>	NA	Nacional

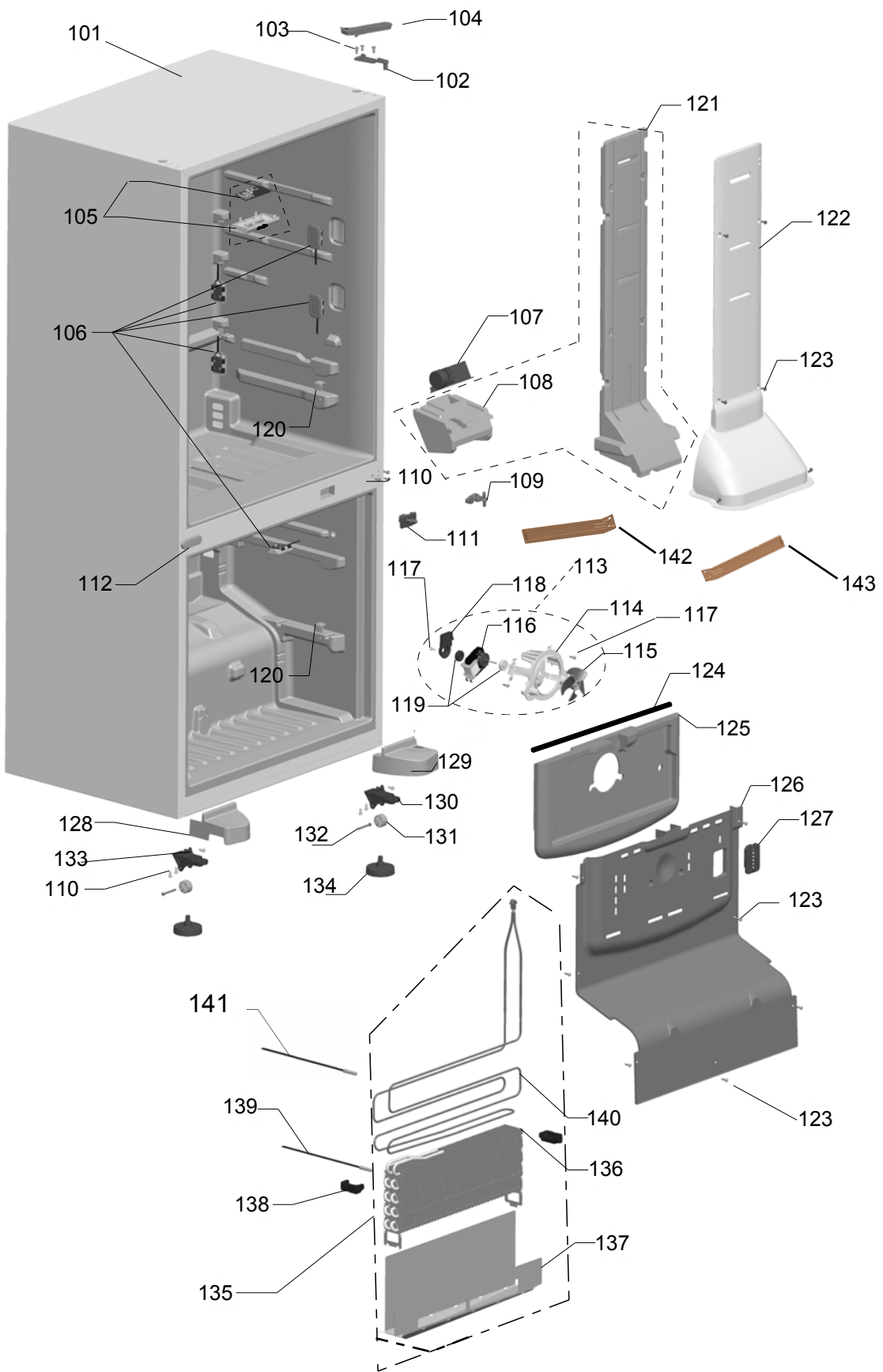

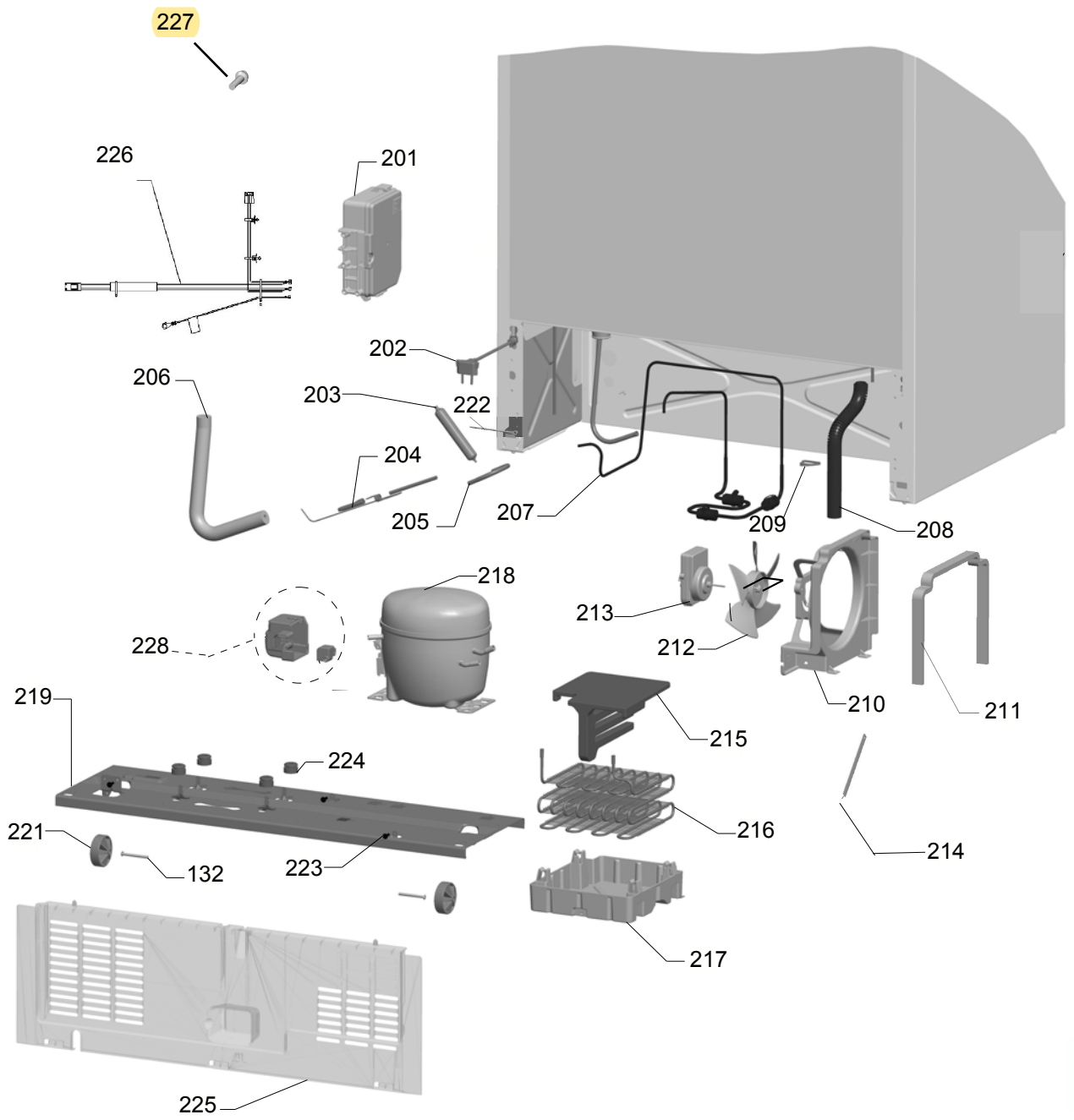

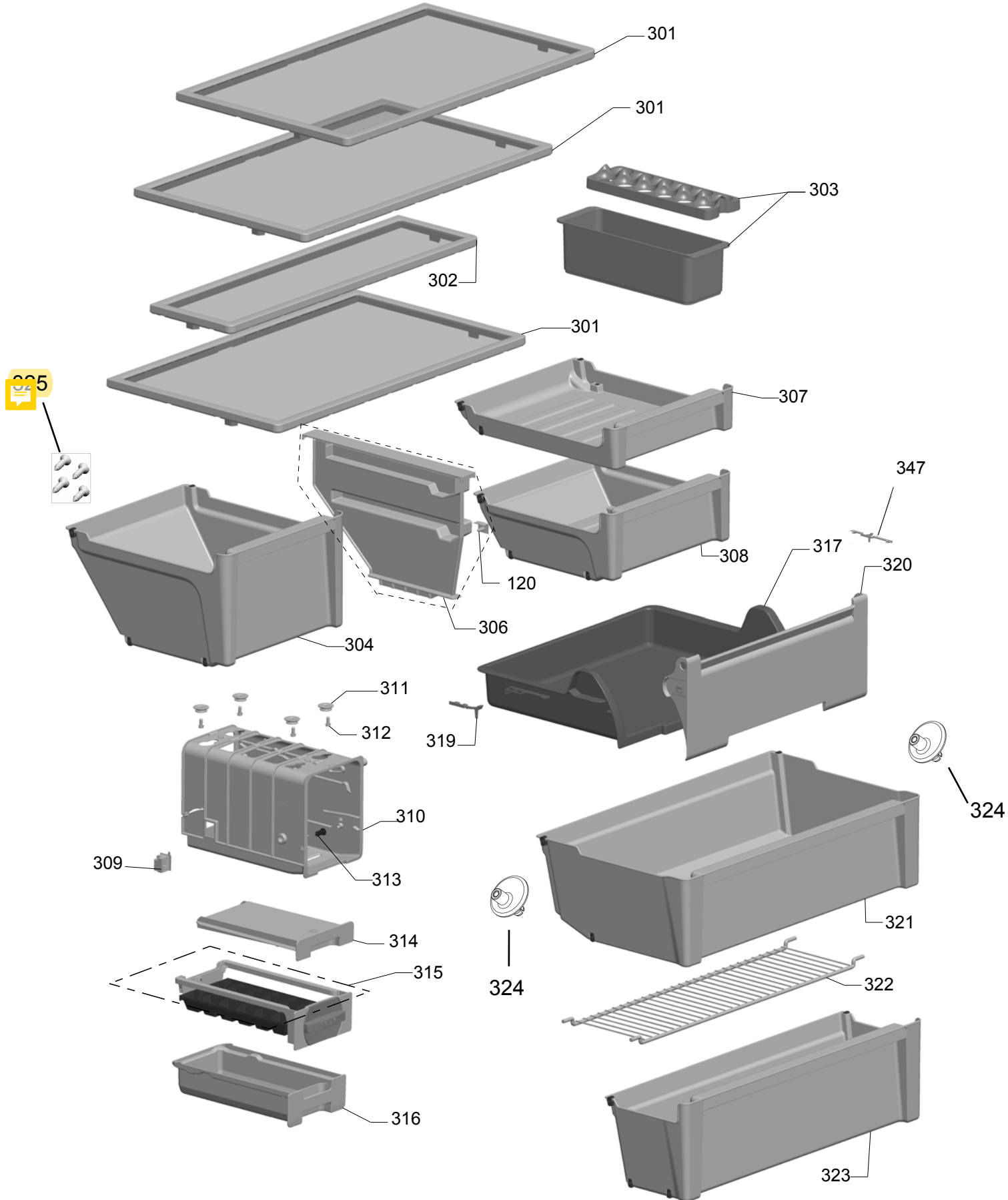

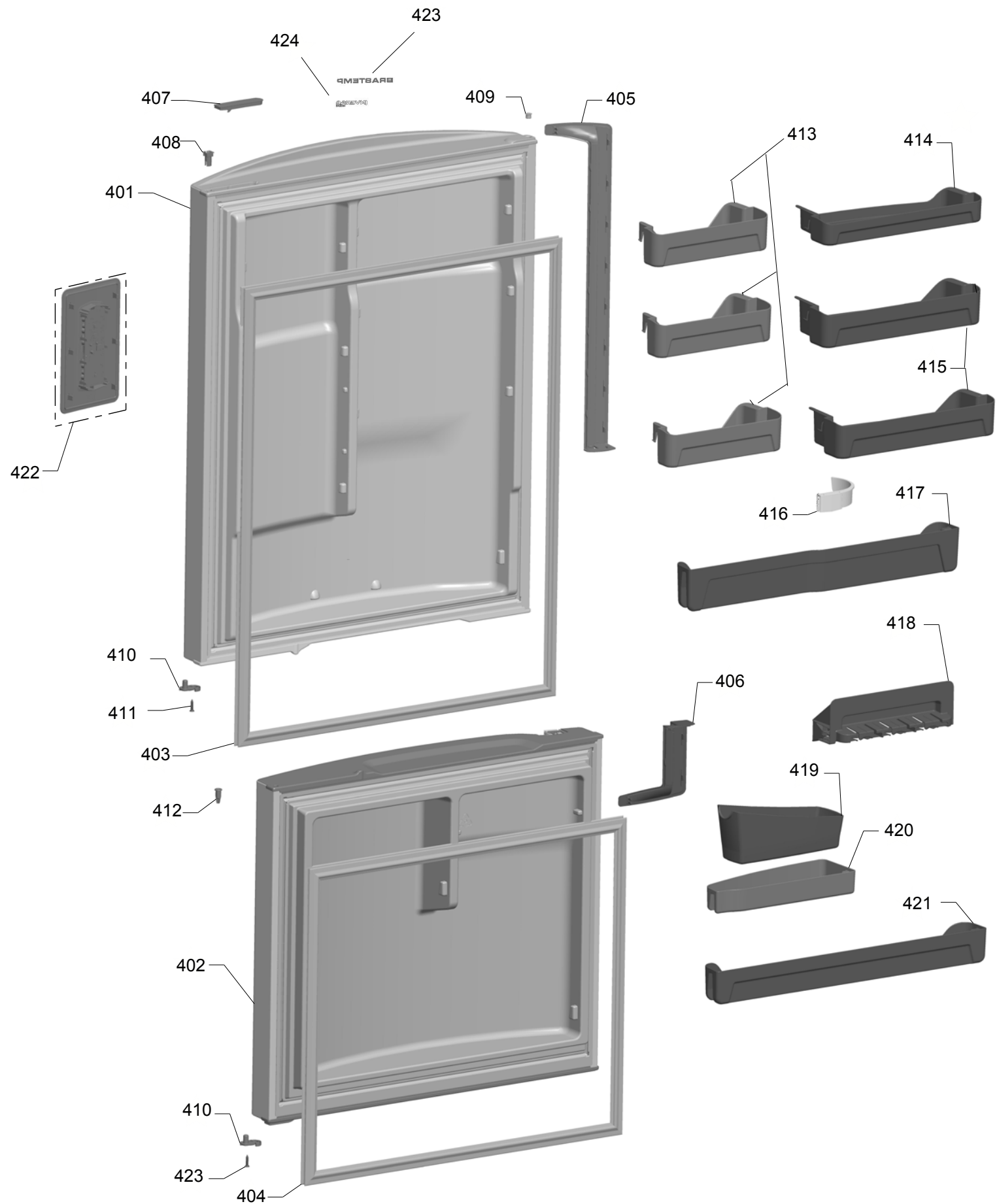

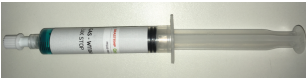

501

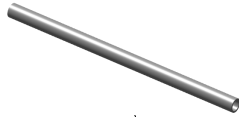

532



504



503

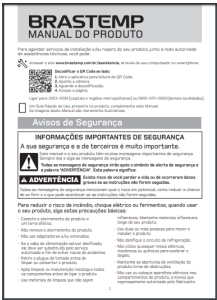

523

520



554

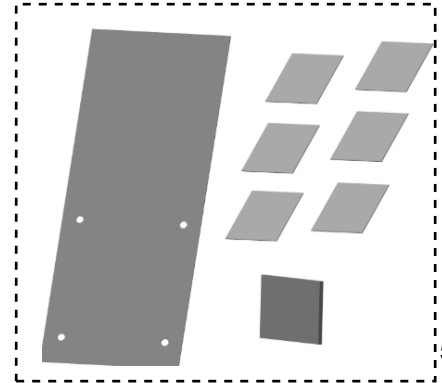

517



555



508



564



506

505

506

506

506

506



522

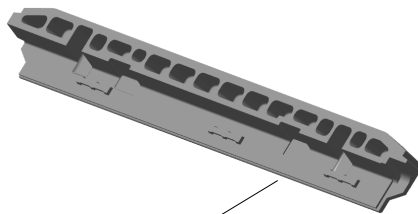

502

556

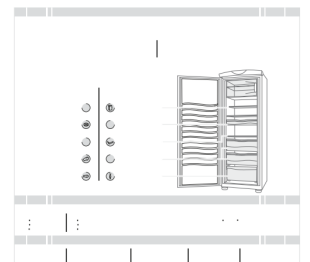

516

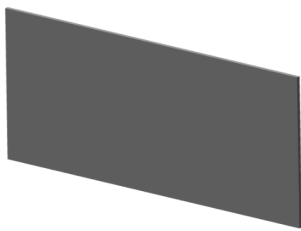

507



515 515

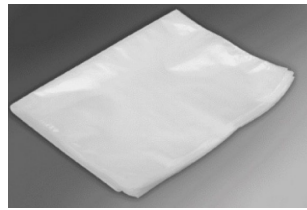

509

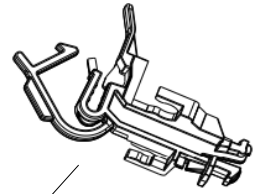

547

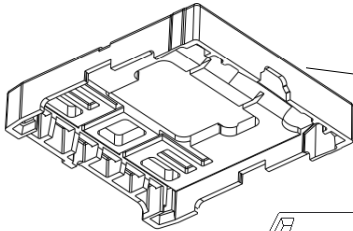

543

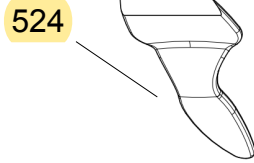

524



526



549

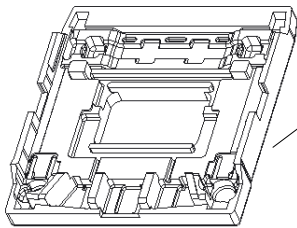

542



525



528



529

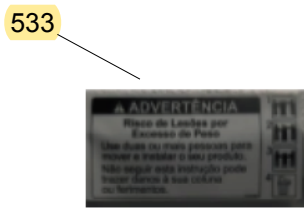

533



530

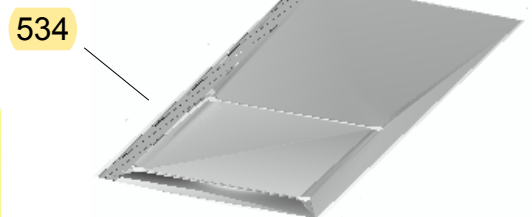

534



535



537

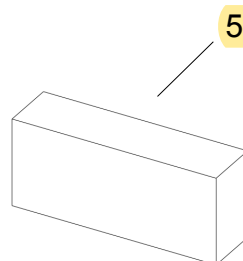

538



539

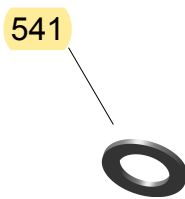

541



544



545



548



548

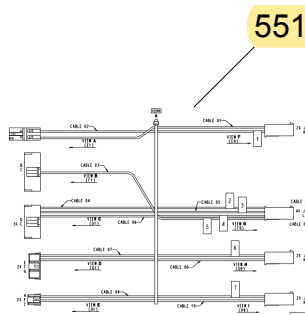

551



552



553

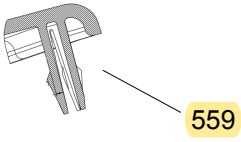

559



561

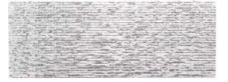

562

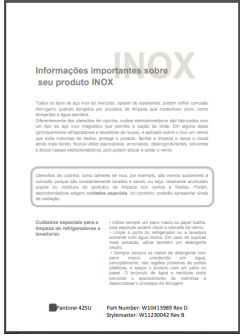

531

563

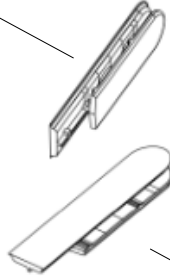

563



564



565