

**BRASTEMP**

# **CATÁLOGO DE PEÇAS**

**Lavadora Brastemp 15kg**

**BWK15AB**

<b>Revisão</b>	<b>Motivo</b>	<b>Páginas Alteradas</b>	<b>Elaborado Por</b>	<b>Revisado Por</b>	<b>Data</b>
Clique aqui para digitar texto.	Clique aqui para digitar texto.	Clique aqui para digitar texto.	Clique aqui para digitar texto.	Clique aqui para digitar texto.	Clique aqui para digitar texto.

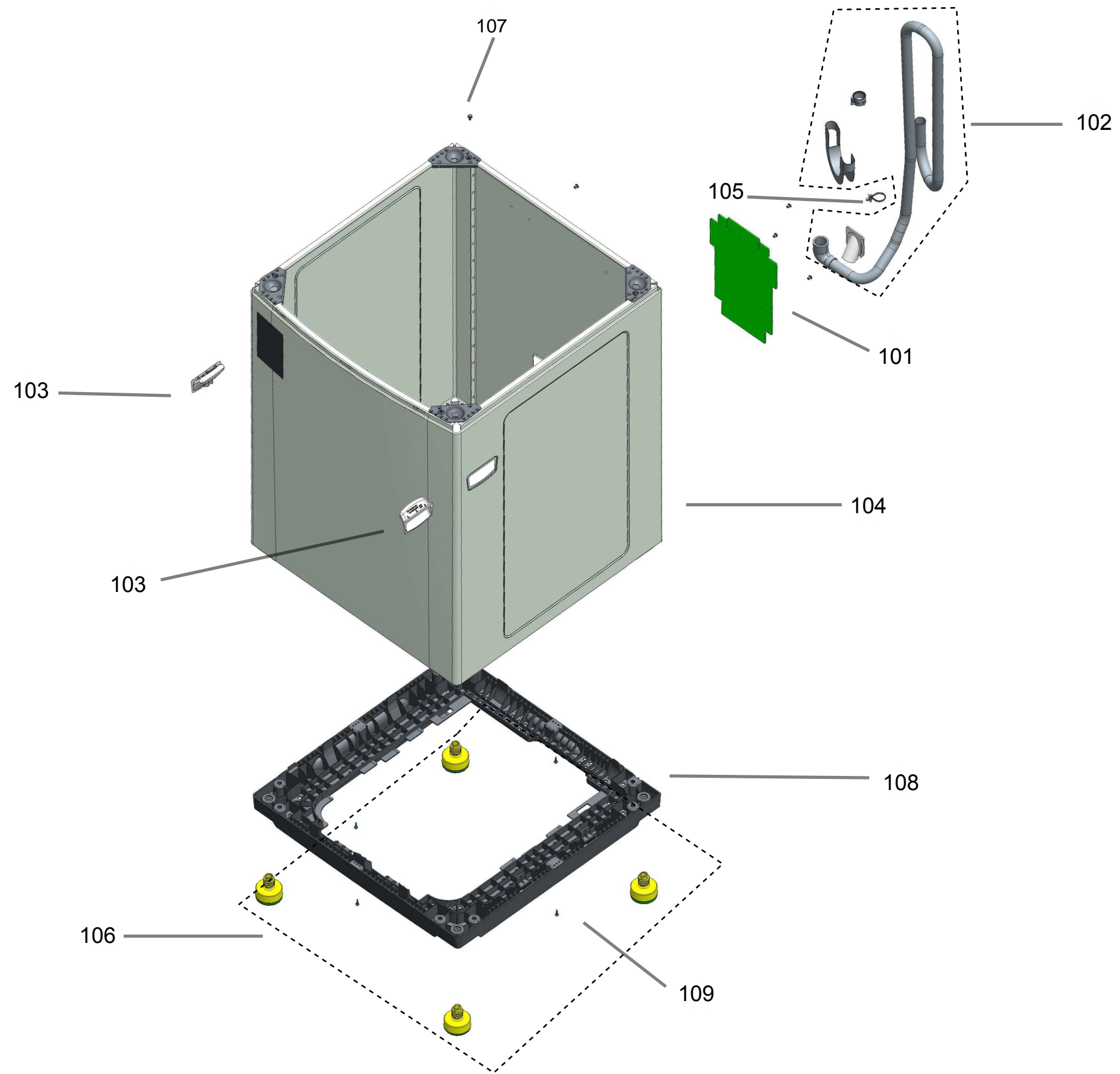

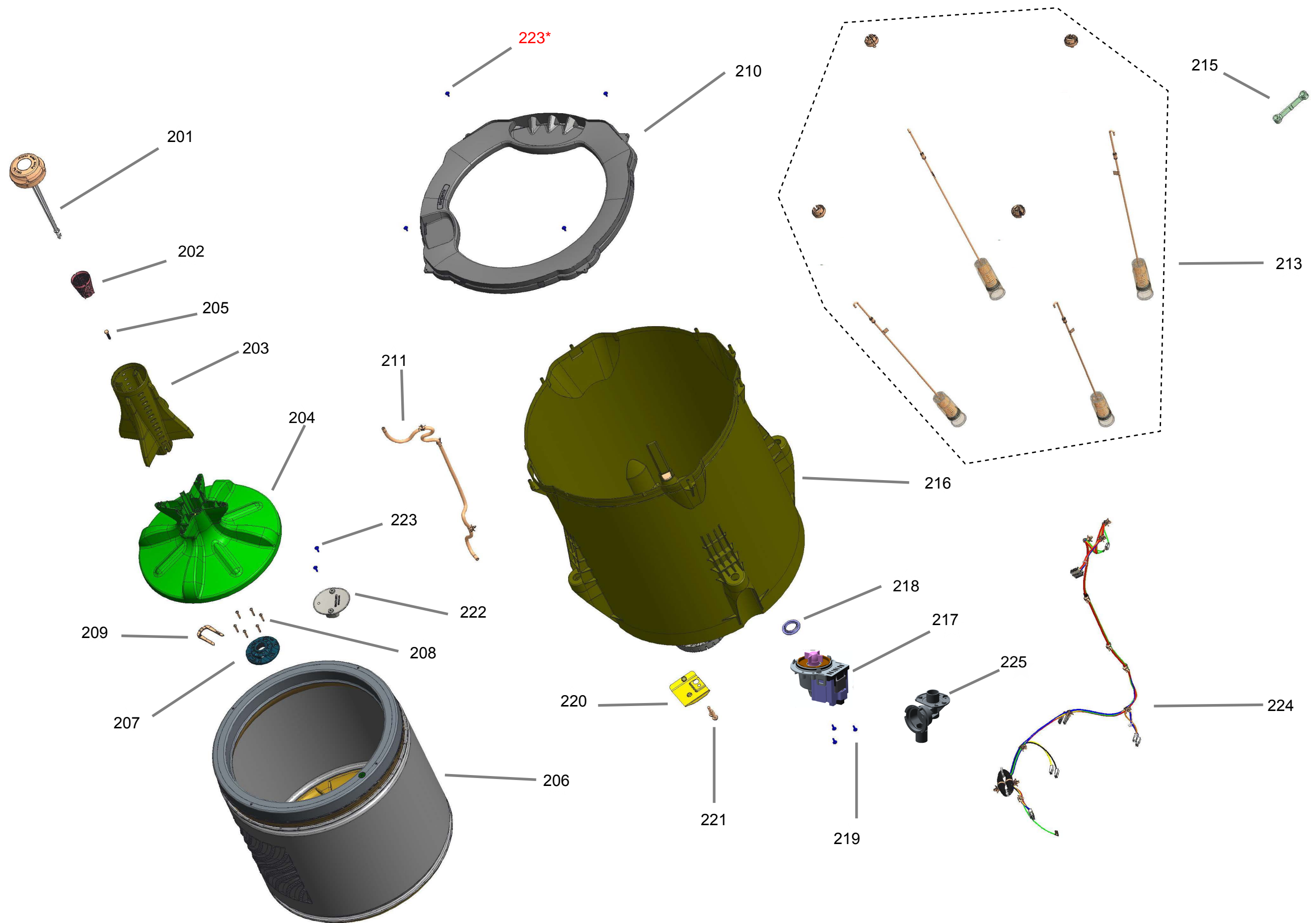

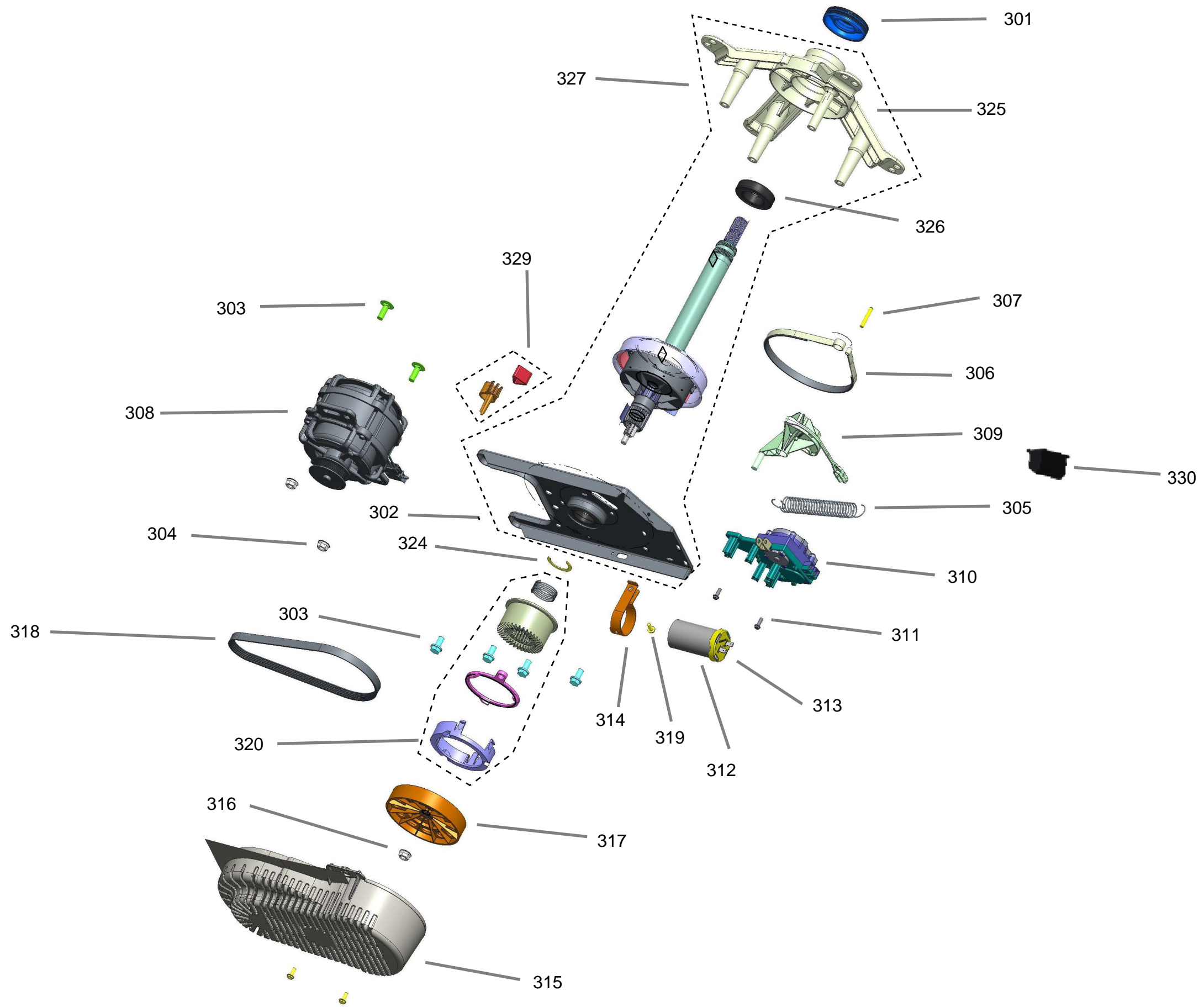



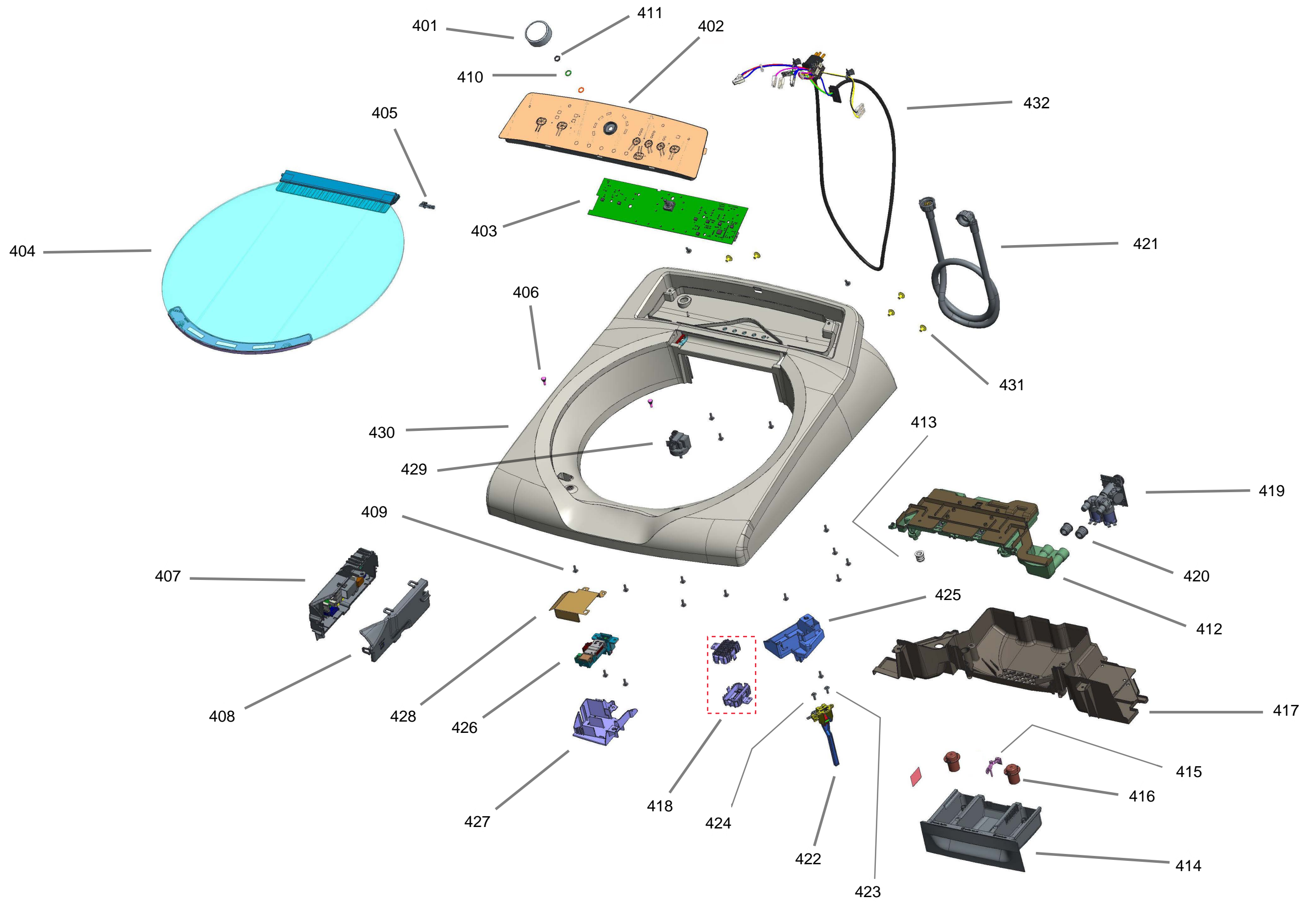

501



EMBALAGEM  
SACO  
PLASTICO  
TERMO-  
COMPRESSIVEL

502

503



504



505

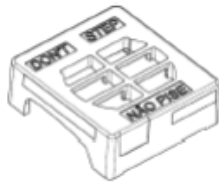

506



508



507



510



509



512



511



514

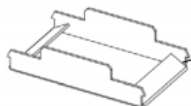

ETIQUETA DE  
IDENTIFICACAO

515

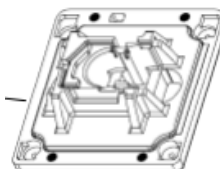

513