

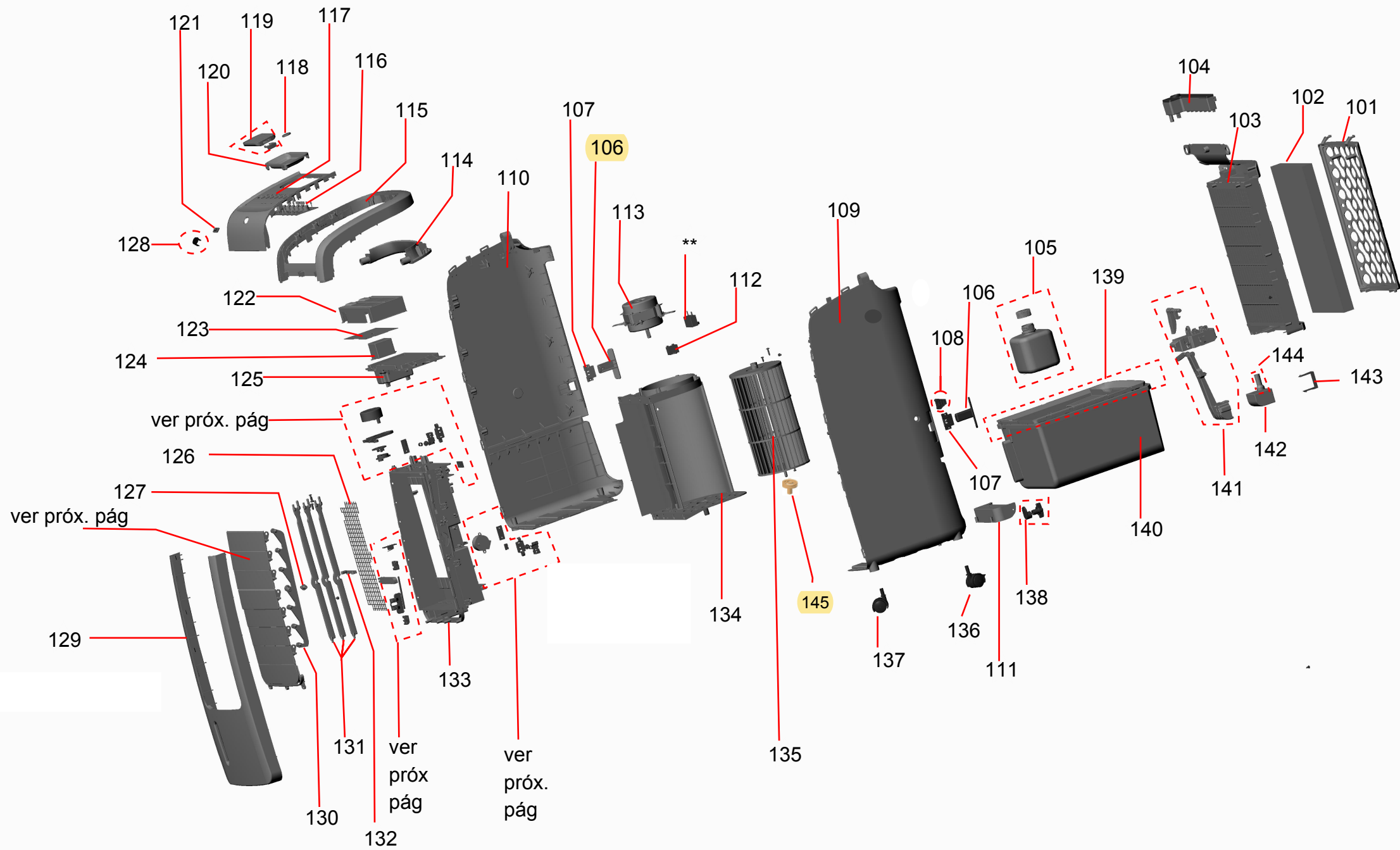



CATÁLOGO DE PEÇAS



CLIMATIZADOR

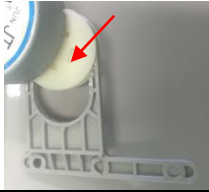

C1Ø07AB

Revisão	Motivo	Páginas Alteradas	Elaborado Por	Revisado Por	Data
00	Lançamento	Todas	Susy Dirani	ACIT	01/10/2014

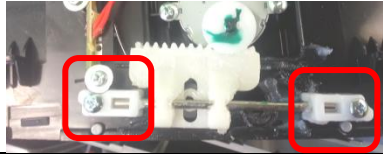
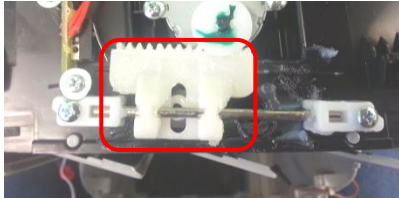
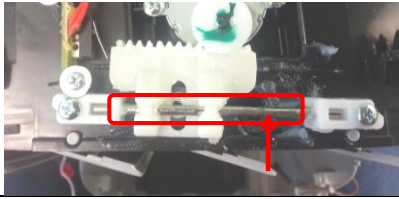
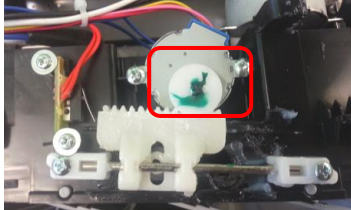
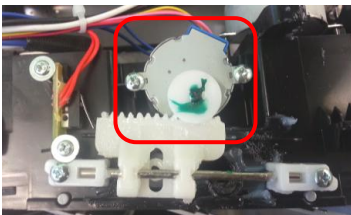

INFORMAÇÕES COMPLEMENTARES		
REF	DESCRIÇÃO/ OBSERVAÇÃO	FOTO
201	MOTOR SINCRONO 127V 3.3D.AF2806K.03XX (Motor síncrono das aletas verticais)	
201	MOTOR SINCRONO 220V 3.3D.AF2806K.06XX (Motor síncrono das aletas verticais)	
202	GUIA HASTE VERTICAL	
203	ENGRENAGEM DO CLIMATIZADOR	
204	ENGRENAGEM EXCENTRICA VERTICAL	

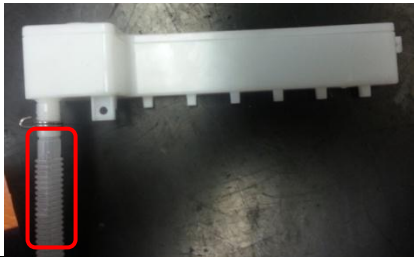
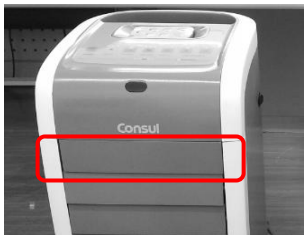
REF	DESCRIÇÃO/ OBSERVAÇÃO	FOTO
301	GRADE TERMOPAR (Sensor de temperatura)	
302	PLACA INTERRUPTOR	
303	FIXADOR DO EIXO	
305	ENGRENAGEM	
306	EIXO	
307	RODA ENGRENAGEM	
308	MOTOR PASSO ALETA	

REF	DESCRIÇÃO/ OBSERVAÇÃO	FOTO
401	TUBULAÇÃO DE ÁGUA SUPERIOR (MANGUEIRA DE ÁGUA)	
402	PERSIANAS HORIZONTAIS (resfriamento)	
403	PERSIANAS DECORATIVA (REFRIGERAÇÃO)	
404	PERSIANAS HORIZONTAIS B (RESFRIAMENTO)	

502



504



509



510



511

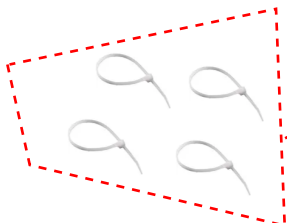

508

