

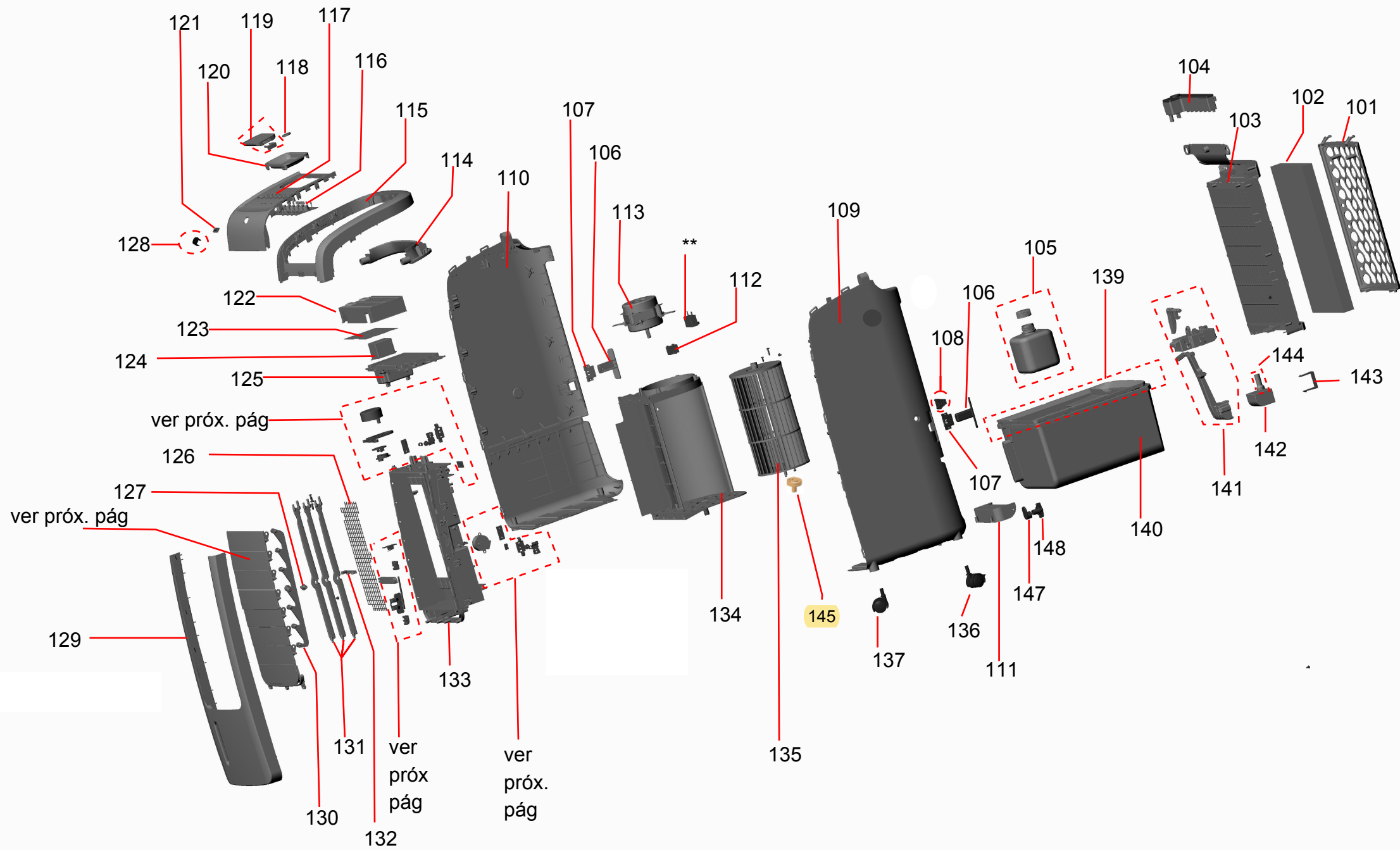



CATÁLOGO DE PEÇAS



CLIMATIZADOR

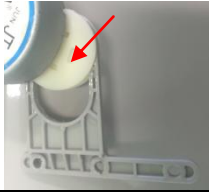

C1Ø07AT

Revisão	Motivo	Páginas Alteradas	Elaborado Por	Revisado Por	Data
00	Lançamento	Todas	Susy Dirani	ACIT	01/10/2014

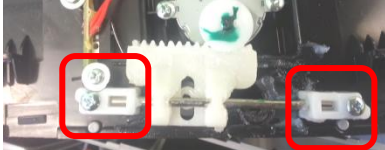
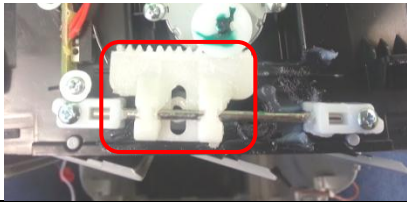
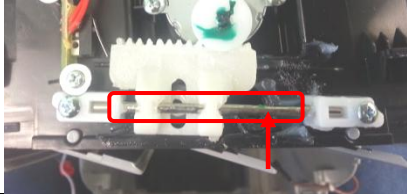
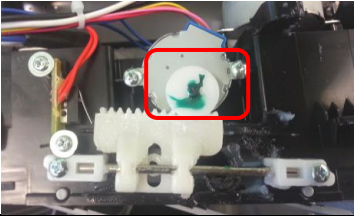
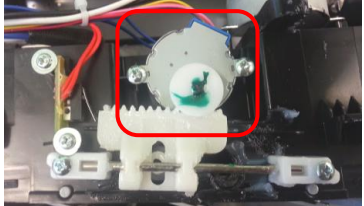

INFORMAÇÕES COMPLEMENTARES		
REF	DESCRIÇÃO/ OBSERVAÇÃO	FOTO
201	MOTOR SINCRONO 127V 3.3D.AF2806K.03XX (Motor síncrono das aletas verticais)	
201	MOTOR SINCRONO 220V 3.3D.AF2806K.06XX (Motor síncrono das aletas verticais)	
202	GUIA HASTE VERTICAL	
203	ENGRENAGE EXENTRICA VERTICAL	
204	ENGRENAGEM EXCENTRICA VERTICAL COBERT	

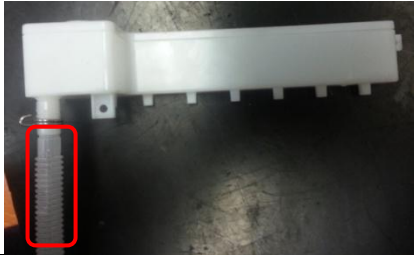
REF	DESCRIÇÃO/ OBSERVAÇÃO	FOTO
301	GRADE TERMOPAR (Sensor de temperatura)	
302	PLACA INTERRUPTOR	
303	FIXADOR DO EIXO	
305	ENGRENAGEM	
306	EIXO	
307	RODA ENGRENAGEM	
308	MOTOR PASSO ALETA	

REF	DESCRIÇÃO/ OBSERVAÇÃO	FOTO
401	TUBULAÇÃO DE ÁGUA SUPERIOR (MANGUEIRA DE ÁGUA)	
402	PERSIANAS HORIZ A TITÂNIO (RESFRIAMENTO) Cor: Titanium	
403	PERSIANAS DECORATIVA TITÂNIO (REFRIG) Cor: Titanium	
404	Cor: Titanium ALETA HORIZONTAL FRONT CINZA B	