

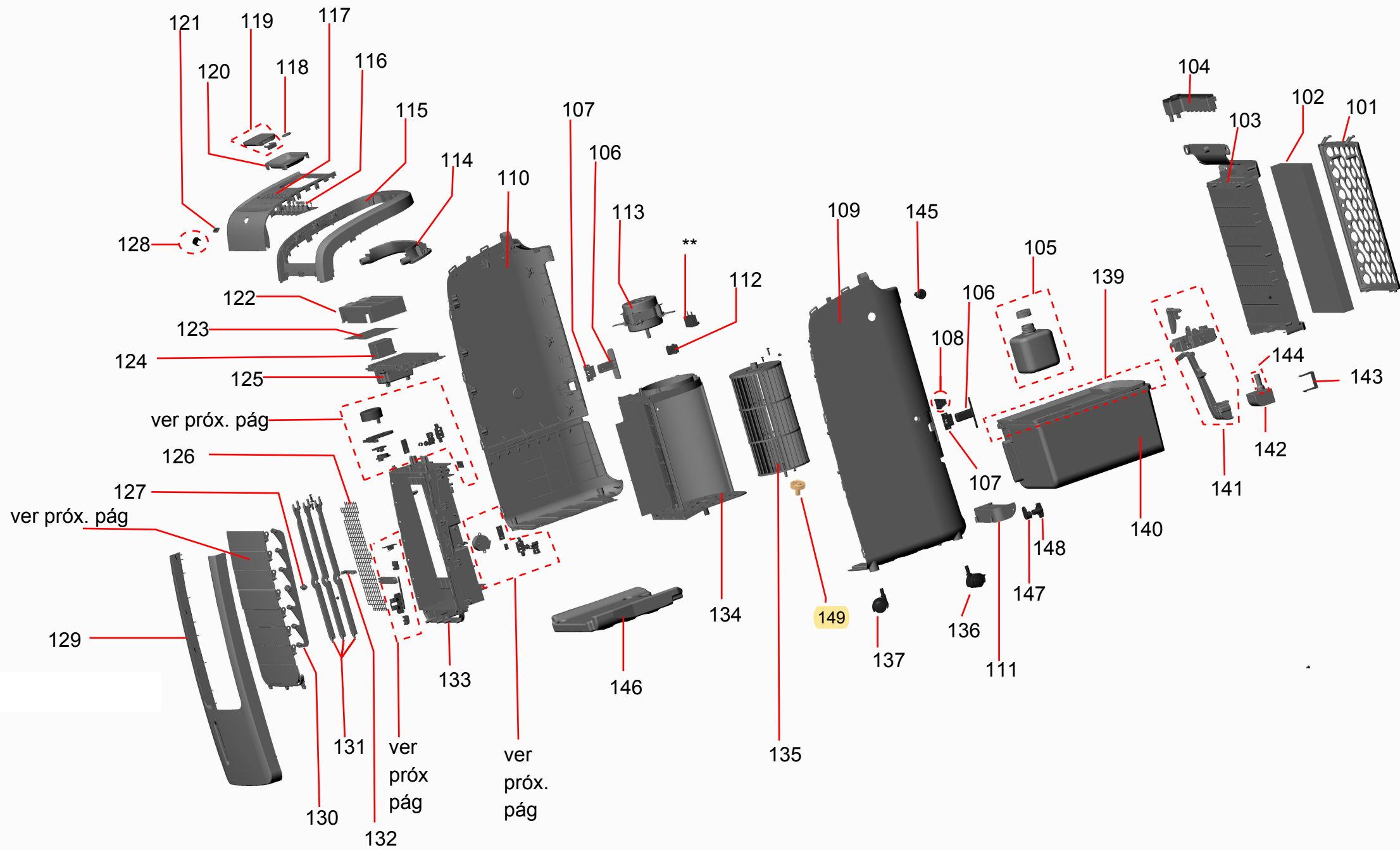





# CATÁLOGO DE PEÇAS



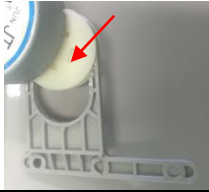

## CLIMATIZADOR

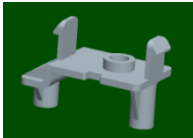
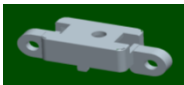



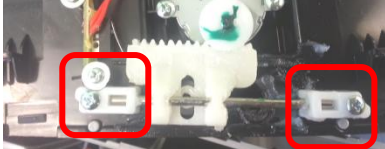

C1R07AF

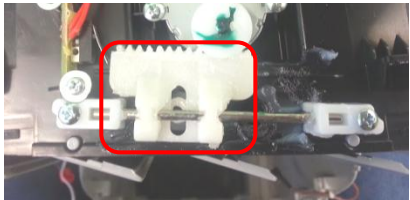
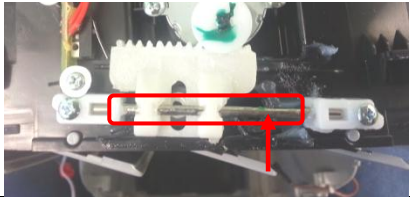
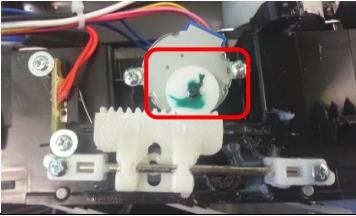
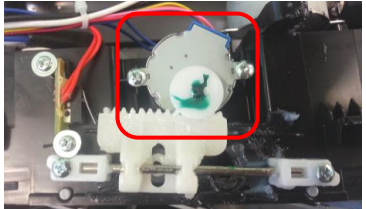



| Revisão | Motivo     | Páginas Alteradas | Elaborado Por | Revisado Por | Data       |
|---------|------------|-------------------|---------------|--------------|------------|
| 00      | Lançamento | Todas             | Susy Dirani   | ACIT         | 01/10/2014 |

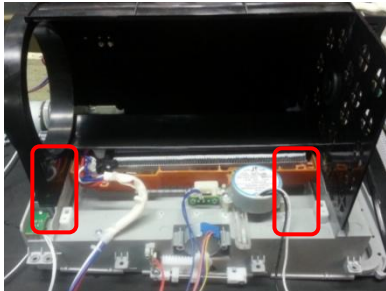
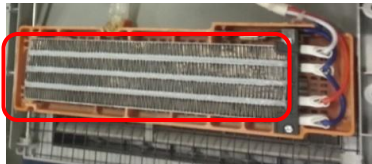

| INFORMAÇÕES COMPLEMENTARES |   |   |
|----------------------------|---|---|
| REF                        | DESCRIÇÃO/ OBSERVAÇÃO   | FOTO  |
| 201                        | MOTOR SINCRONO 127V<br>3.3D.AF2806K.03XX<br>(Motor síncrono das aletas verticais) |    |
| 201                        | MOTOR SINCRONO 220V<br>3.3D.AF2806K.06XX<br>(Motor síncrono das aletas verticais) |   |
| 202                        | GUIA HASTE VERTICAL   |    |
| 203                        | ENGRENAGE EXENTRICA VERTICAL  |    |
| 204                        | ENGRENAGEM EXCENTRICA VERTICAL  |   |
| 205                        | PLACA INTERRUPTOR LIMITADA 2<br>(Fim de curso da resistência)                     |  |
| 207                        | PROTETOR CONJ INTERRUPTOR<br>(suporte da placa interruptor limitada)              |  |
| 208                        | FIXADOR BASE INTERRUPTOR  |  |
| 209                        | INJETOR INTERRUPTOR   |  |

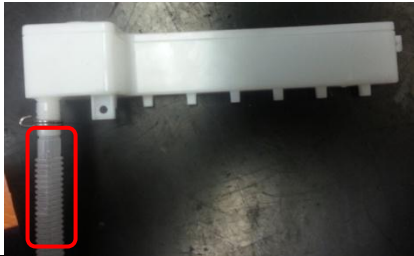
| REF | DESCRIÇÃO/ OBSERVAÇÃO                     | FOTO   |
|-----|---|--|
| 301 | GRADE TERMOPAR<br>(Sensor de temperatura) |    |
| 302 | PLACA INTERRUPTOR                         |    |
| 303 | FIXADOR DO EIXO                           |    |
| 304 | PTC ENGRENAGEM                            |   |
| 305 | ENGRENAGEM                                |  |
| 306 | EIXO                                      |  |
| 307 | RODA ENGRENAGEM                           |  |
| 308 | MOTOR PASSO ALETA                         |  |

| REF | DESCRIÇÃO/ OBSERVAÇÃO   | FOTO   |
|-----|---|--|
| 401 | SUPORE MOTOR CJ 127V<br>(Motor síncrono da resistência)                         |   |
| 401 | SUPORE MOTOR CONJUNTO<br>220V<br>(Motor síncrono da resistência)                |  |
| 402 | INTERRUPTOR PLACA   |    |
| 403 | ENGRENAGEM CREMALHEIRA<br>BLOCO   |    |
| 404 | ENGRENAGEM DA RODA PTC  |  |
| 405 | ENGRENAGEM TRILHO<br>(Trilho para a resistência)                                |  |
| 406 | RESISTÊNCIA 127V<br>1.RD.AF2806K.01XX   |  |
| 406 | RESISTÊNCIA 220V<br>1.RD.AF2806K.07XX   |  |
| 407 | SUPORE RESISTÊNCIA<br>1.RS.AF2806K.35XX<br>(Obs.: cor meramente<br>ilustrativa) |  |
| 408 | TAMPA DA RESISTÊNCIA<br>1.RS.AF2806K.44XX                                       |  |

| REF | DESCRIÇÃO/ OBSERVAÇÃO                                  | FOTO   |
|-----|--|--|
| 501 | TUBULAÇÃO DE ÁGUA SUPERIOR (MANGUEIRA DE ÁGUA)         |    |
| 502 | PERSIANAS HORIZONTAIS A (Aquecimento)<br>Cor: Titanium |    |
| 503 | PERSIANAS DECORATIVAS(AQUECIMENTO)<br>Cor: Titanium    |   |
| 504 | PERSIANAS HORIZONTAIS B (Aquecimento)<br>Cor: Titanium |  |



505



506



509



510

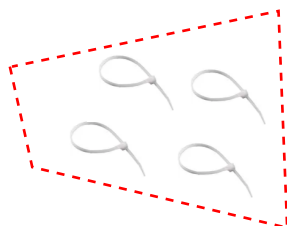

511

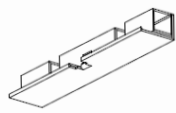

508