

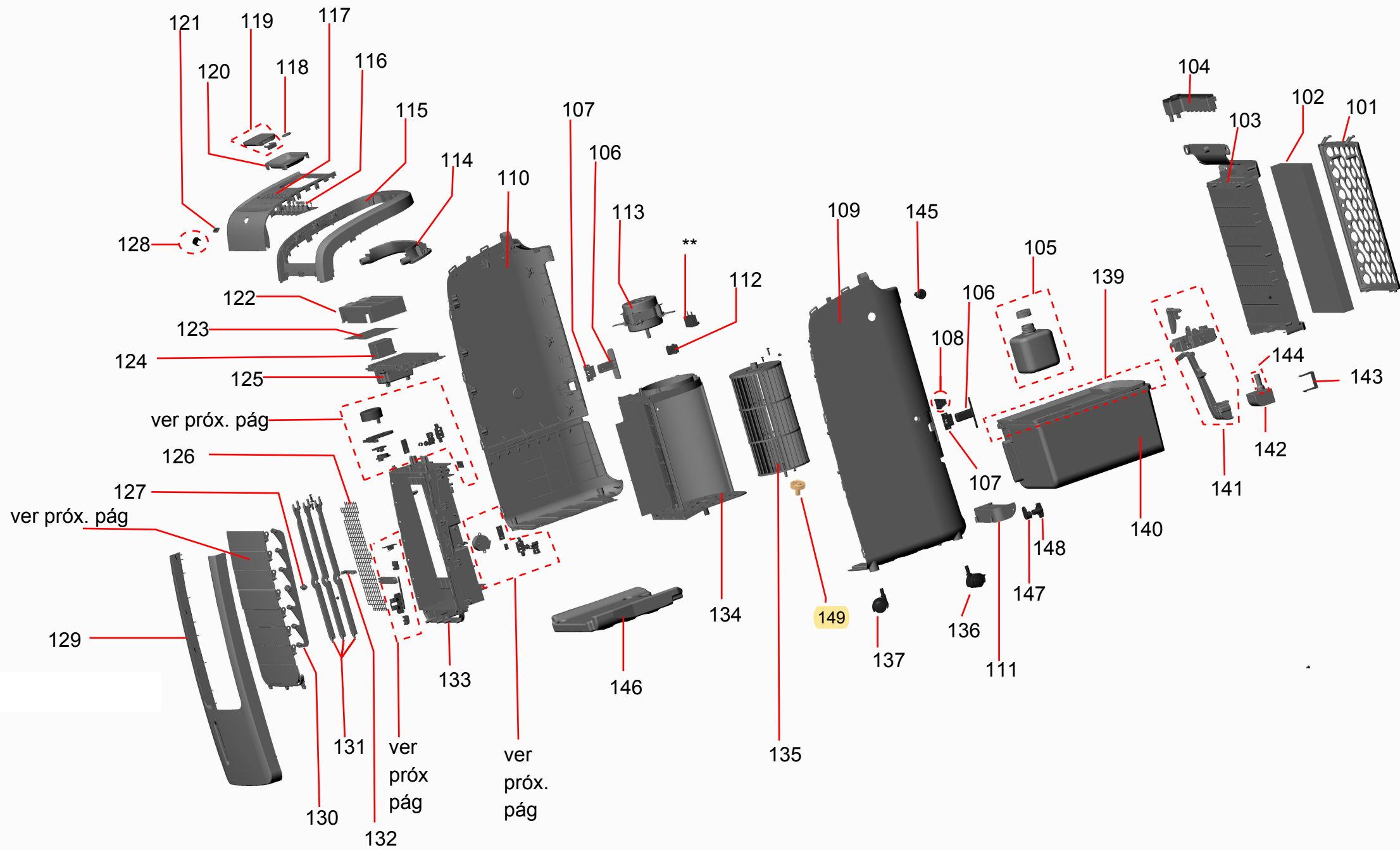





# CATÁLOGO DE PEÇAS



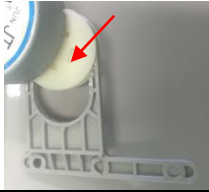

## CLIMATIZADOR

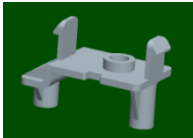
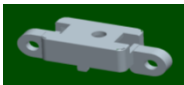



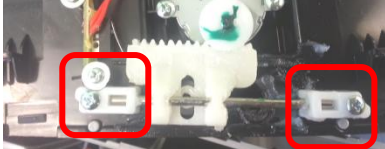

C1R07AF

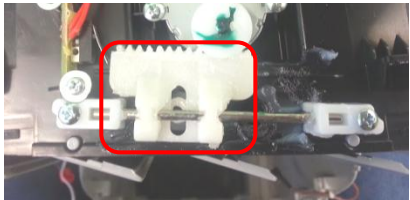
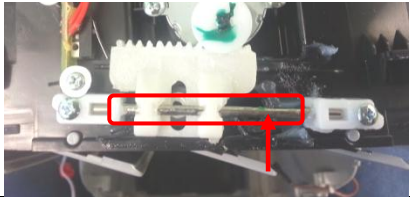
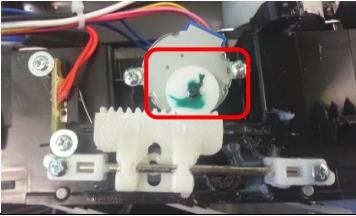
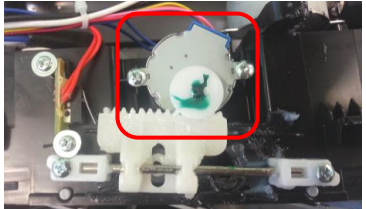

Revisão	Motivo	Páginas Alteradas	Elaborado Por	Revisado Por	Data
00	Lançamento	Todas	Susy Dirani	ACIT	01/10/2014

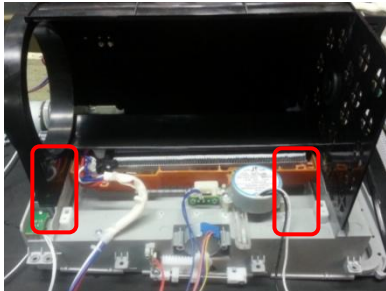
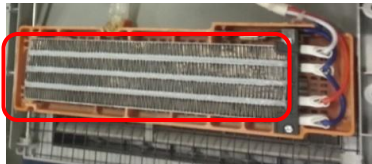

INFORMAÇÕES COMPLEMENTARES		
REF	DESCRIÇÃO/ OBSERVAÇÃO	FOTO
201	MOTOR SINCRONO 127V 3.3D.AF2806K.03XX (Motor síncrono das aletas verticais)	
201	MOTOR SINCRONO 220V 3.3D.AF2806K.06XX (Motor síncrono das aletas verticais)	
202	GUIA HASTE VERTICAL	
203	ENGRENAGE EXENTRICA VERTICAL	
204	ENGRENAGEM EXCENTRICA VERTICAL	
205	PLACA INTERRUPTOR LIMITADA 2 (Fim de curso da resistência)	
207	PROTETOR CONJ INTERRUPTOR (suporte da placa interruptor limitada)	
208	FIXADOR BASE INTERRUPTOR	
209	INJETOR INTERRUPTOR	

REF	DESCRIÇÃO/ OBSERVAÇÃO	FOTO
301	GRADE TERMOPAR (Sensor de temperatura)	
302	PLACA INTERRUPTOR	
303	FIXADOR DO EIXO	
304	PTC ENGRENAGEM	
305	ENGRENAGEM	
306	EIXO	
307	RODA ENGRENAGEM	
308	MOTOR PASSO ALETA	

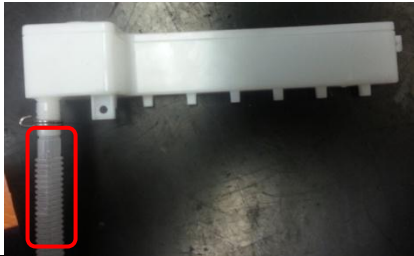
REF	DESCRIÇÃO/ OBSERVAÇÃO	FOTO
401	SUPORE MOTOR CJ 127V (Motor síncrono da resistência)	
401	SUPORE MOTOR CONJUNTO 220V (Motor síncrono da resistência)	
402	INTERRUPTOR PLACA	
403	ENGRENAGEM CREMALHEIRA BLOCO	
404	ENGRENAGEM DA RODA PTC	
405	ENGRENAGEM TRILHO (Trilho para a resistência)	
406	RESISTÊNCIA 127V 1.RD.AF2806K.01XX	
406	RESISTÊNCIA 220V 1.RD.AF2806K.07XX	
407	SUPORE RESISTÊNCIA 1.RS.AF2806K.35XX (Obs.: cor meramente ilustrativa)	
408	TAMPA DA RESISTÊNCIA 1.RS.AF2806K.44XX	

REF	DESCRIÇÃO/ OBSERVAÇÃO	FOTO
501	TUBULAÇÃO DE ÁGUA SUPERIOR (MANGUEIRA DE ÁGUA)	
502	PERSIANAS HORIZONTAIS A (Aquecimento) Cor: Titanium	
503	PERSIANAS DECORATIVAS(AQUECIMENTO) Cor: Titanium	
504	PERSIANAS HORIZONTAIS B (Aquecimento) Cor: Titanium	