

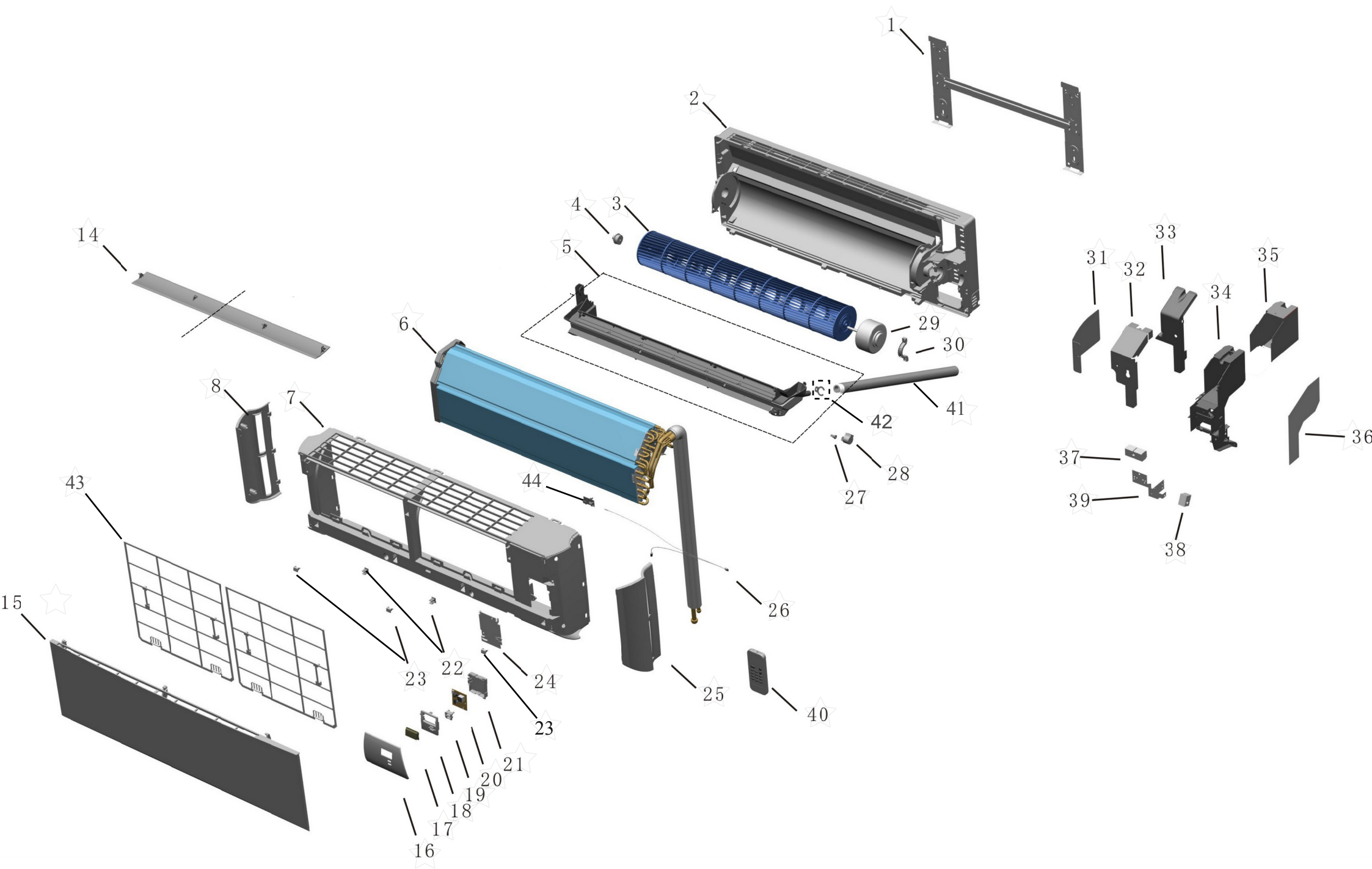











CATÁLOGO DE PEÇAS

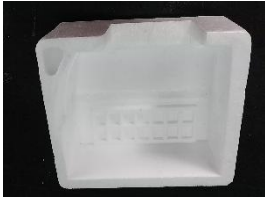

CONDICIONADOR DE AR SPLIT CBE18AF

Revisão	Motivo	Páginas Alteradas	Elaborado Por	Data
00	Lançamento	Todas	Susy Dirani	14/10/13



INFORMAÇÕES COMPLEMENTARES			
REF	CÓDIGO	DESCRIÇÃO/ OBSERVAÇÃO	FOTO
45	W10602427	Tubo entrada evaporador - 1544453	
46	W10396953	Tubo Saída unidade interna 5/8 - 1437667	
47	W10201978	Isolação da Tubulação - 1315398	
48	W10322320	Filtro HEPA	
49	W10601094	Caixa de papelão 18k IDU	
50	W10601038	Calço embalagem EPS esquerdo - 1502975	
51	W10601039	Calço embalagem EPS direito - 1502976	
52	W10201956	Fio Terra 1 - 290mm	
53	W10601976	Fio Terra - 1225958	

REF	CÓDIGO	DESCRIÇÃO/ OBSERVAÇÃO	FOTO
54	W10201957	Fio Marrom - 1262425	
55	W10602090	Fio Conexão - 1262333	
56	W10616422	Base plástica (lateral do evaporador)	
57	W10503816	Separador Agua Evaporador - 1465448	
58	W10324369	Tampa traseira 2	
59	W10324368	Tampa traseira 1	
60	W10602475	Saco Plástico embalagem - 1325322	
61	W10602463	Presilha da fiação - 1221123	
62	W10324354	Presilha da fiação	
63	W10324357	Suporte do Filtro	

REF	IMAGEM/DESENHO	DESCRIÇÃO
64		ETIQUETA CONS. ENERGIA CBE18AB
65		MANUAL KIT
66		CORDAO DE ALIMENTACAO 3P BRANCO