



# CATÁLOGO DE PEÇAS

CONDICIONADOR DE AR SPLIT



CBJ09CB

CBF09CB

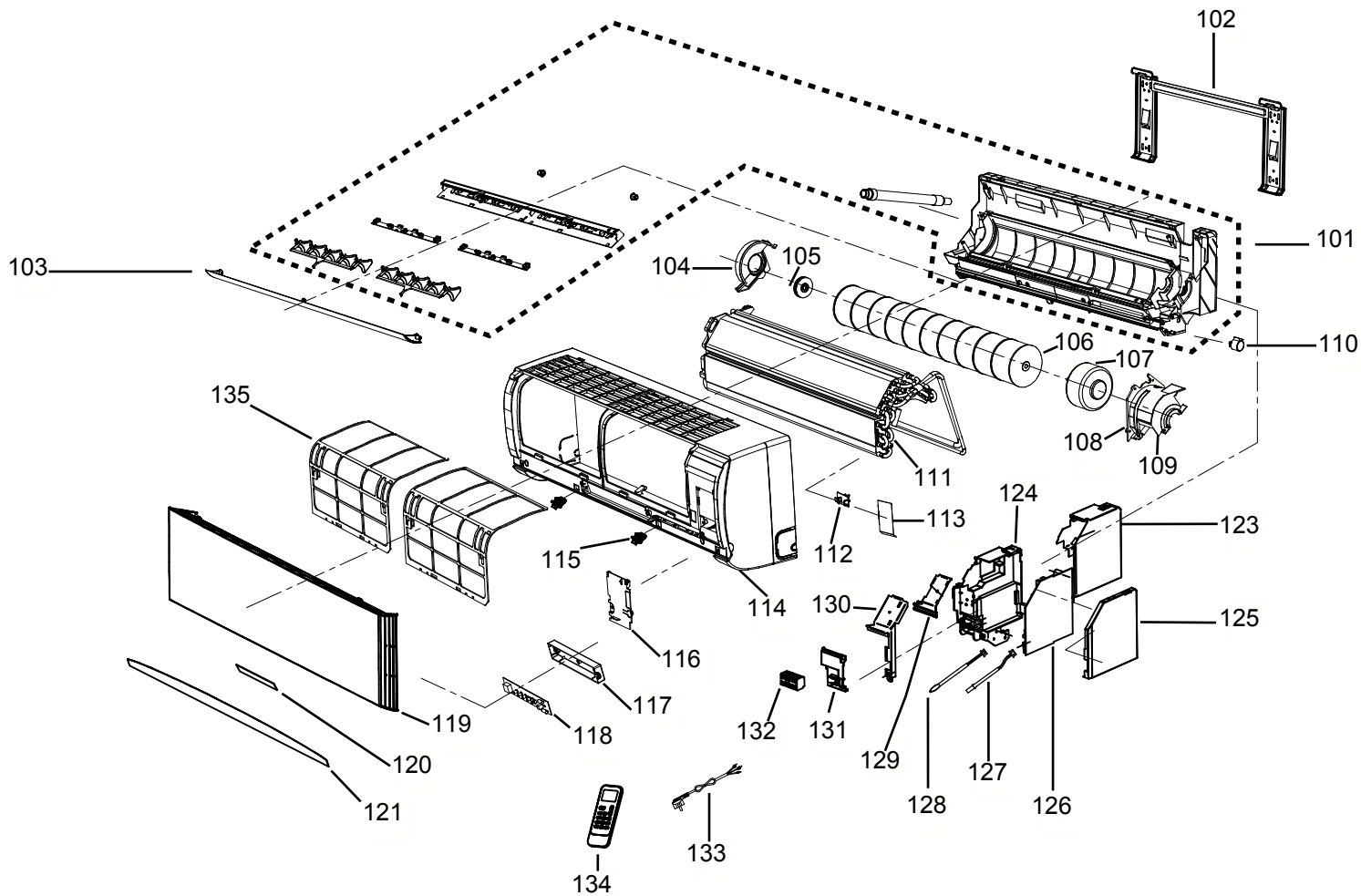

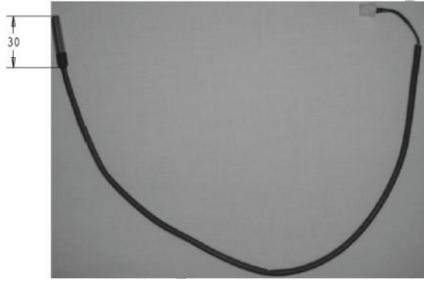
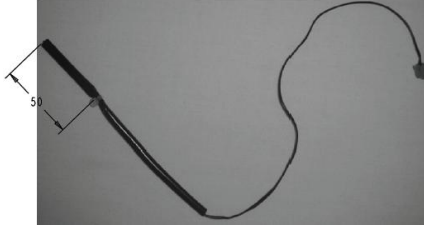
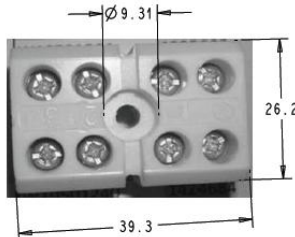
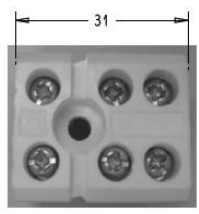

Revisão	Motivo	Páginas Alteradas	Elaborado Por	Data
00	Lançamento	Todas	Susy Dirani	9/10/12

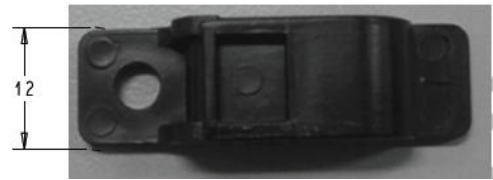

Informações complementares

Ref.	Código	Descrição/ Observação	Foto/ Referência
127	W10501053	Sensor de Temperatura Comprimento total: 450mm	
128	W10501052	Sensor de Temperatura Comprimento total: 430mm	
132	W10501059	Borneira (de conexão)	
999	W10501244	Borneira (de alimentação)	
999	W10501072	Filtro de Ar (filtro de carbono)	
999	W10202485	Saco Plástico embalagem	Embalagem da Unidade Interna
999	W10501051	Saco Plástico	Embalagem do controle remoto
999	W10501266	Calço Embalagem EPS	Lado esquerdo
999	W10501267	Calço Embalagem EPS	Lado direito
999	W10476219	Presilha da Fiação	

REF	IMAGEM/DESENHO	DESCRIÇÃO
136	 <p><b>Energia</b> (Elétrica) Forno de MICRO-ONDAS</p> <p>Fabricante: WHIRLPOOL  Marca: CONSUL  Modelo/tensão: CMS4SARBNA / 220 V</p> <p>Mais Eficiente</p> <p>Menos Eficiente</p> <p>EFICIÊNCIA ENERGÉTICA (%) 56,39  MODO ESPERA (Standby) (kWh/dia) 0,007  Volume Total (litros) 32  Volume Útil (litros) 21</p> <p>Requisitos de Avaliação de Conformidade para Fornos de Micro-Ondas  Instruções de instalação e recomendação de uso, leia o Manual do aparelho</p> <p>PROCEL  PROCEL  INMETRO  Registro Inmetro nº 004787/2017</p>	ETIQUETA EFICIENCIA ENERGETICA 220V
137		CORDAO DE ALIMENTACAO SEM PLUGUE BRANCO
138		SUPORTE DO FILTRO
139		FILTRO DE AR CARBONO
140		FILTRO AR HEPA

141		<p>EMBALAGEM SACO PLASTICO</p>
142		<p>EMBALAGEM SACO PLASTICO DO CONTROLE</p>
143		<p>TAMPA PLASTICO CHASSI</p>
144		<p>EMBALAGEM PAPELÃO ONDULADO</p>
145		<p>CALÇO EPS DIR</p>

146		CALCO EPS ESQ
147		CLIQUE DO TERMISTOR
148		AVISO DE CHOQUE ELETRICO
149		ISOLACAO TERMICA DA TUBULACAO
150		Diagrama Elétrico 9K/12K
151		TUBO DE SUCCAO 3/8
152		TUBO DE DESCARGA DE COBRE DO EVAPORADOR

153		REDE ELETRICA BIVOLT 269MM
154		ABRACADEIRA DE PARAFUSO DA FIAÇAO
155		REDE ELETRICA BIVOLT
156		PRESILHA DA FIAÇÃO
157		FIO CONEXÃO
158		REDE ELETRICA 220V
159		BORNEIRA DA FIAÇAO

160		PRESILHA DO TERMISTOR - 1301100
161		MANUAL DE INSTRUCAO Kit
162		BUCHA DO EIXO DO MOTOR - 1465593
163		PORCA 3/8
164		PORCA