



CATÁLOGO DE PEÇAS





CONDICIONADOR DE AR SPLIT



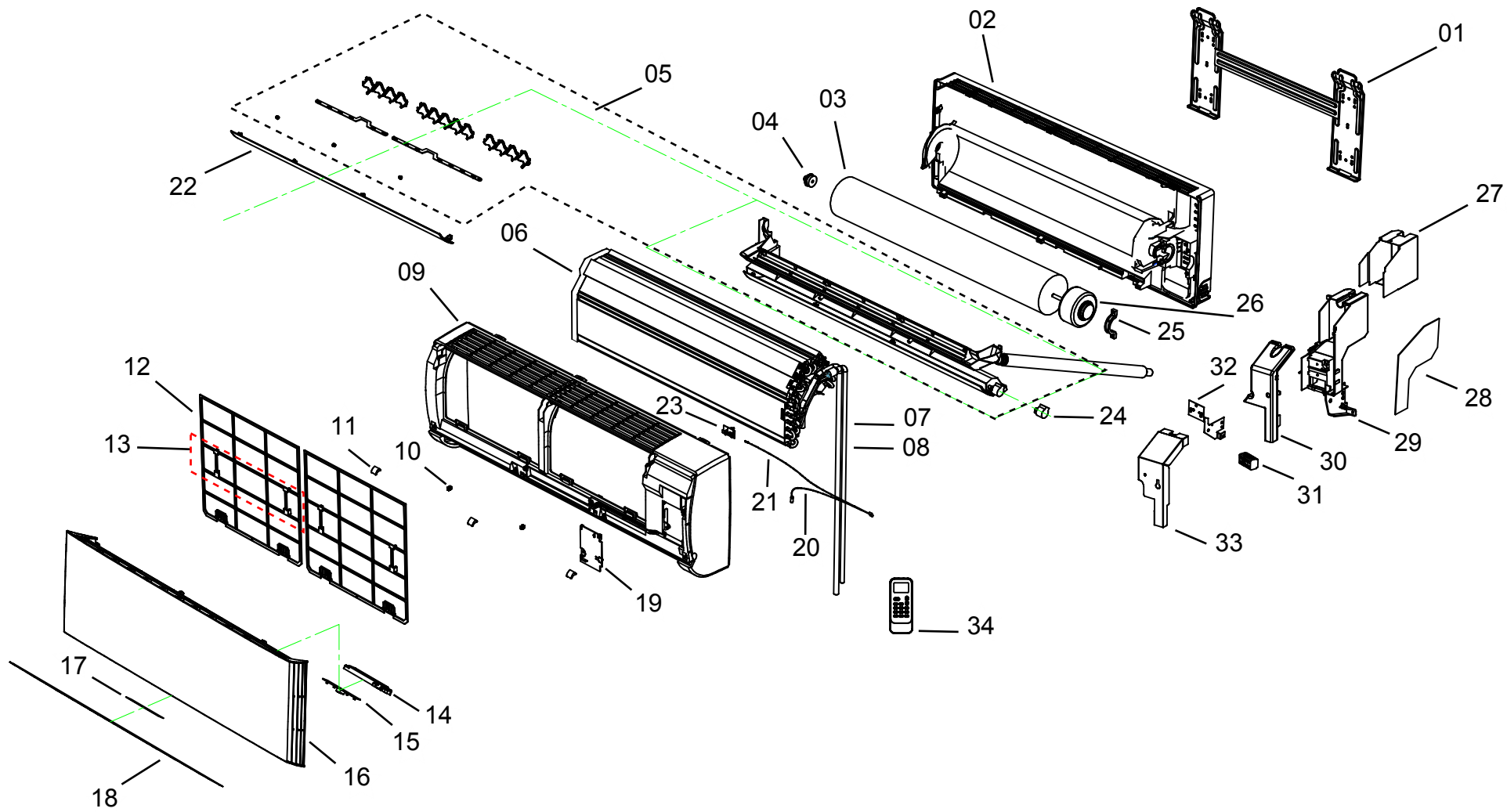

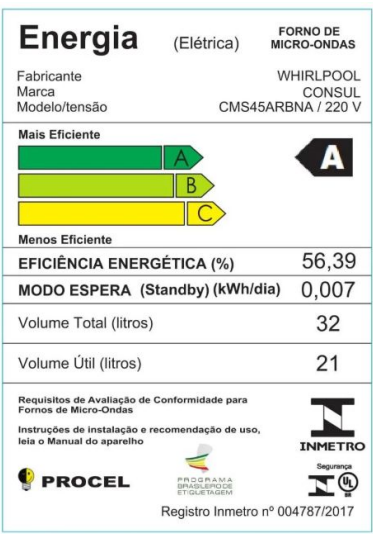

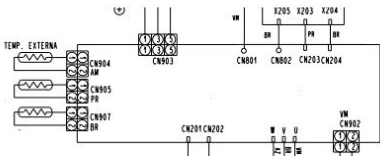
CBJ18CB





CBF18CB

Revisão	Motivo	Páginas Alteradas	Elaborado Por	Data
00	Lançamento	Todas	Susy Dirani	05/12/12

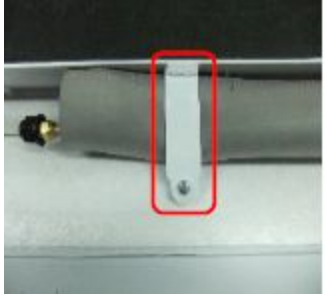

REF	IMAGEM/DESENHO	DESCRIÇÃO
35	 <p>Energia (Elétrica) Forno de MICRO-ONDAS</p> <p>Fabricante: WHIRLPOOL Marca: CONSUL Modelo/tensão: CMS45ARBNA / 220 V</p> <p>Mais Eficiente: A</p> <p>Menos Eficiente: B, C</p> <p>EFICIÊNCIA ENERGÉTICA (%) 56,39 MODO ESPERA (Standby) (kWh/dia) 0,007 Volume Total (litros) 32 Volume Útil (litros) 21</p> <p>Requisitos de Avaliação de Conformidade para Fornos de Micro-Ondas Instruções de instalação e recomendação de uso, veja o Manual do aparelho</p> <p>INMETRO PROCEL PFC - PROGRAMA FEDERAL DE CERTIFICAÇÃO E ETIQUETAGEM Registro Inmetro nº 004787/2017</p>	ETIQUETA CONS. ENERGIA CBF18C 220V
36		CORDAO DE ALIMENTACAO 16A 3P BRANCO
37		Diagrama Elétrico 18K
38		MANUAL DE INSTRUCAO Kit
39	 <p>ADVERTÊNCIA Risco de Choque Elétrico</p> <p>Este aparelho deverá ser reparado somente por pessoal técnico devidamente qualificado. Retire o plugue da tomada antes de efetuar qualquer manutenção no produto. Ricochetes em todos os componentes antes de ligar o produto. Nada remover o aterramento do produto. Ligue o aterramento do produto a um terra elétrico. Não use adaptadores ou "T". Não seguir estas instruções pode trazer risco de vida, saúde ou choque elétrico.</p>	AVISO DE CHOQUE ELETRICO

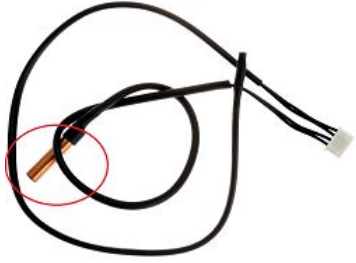
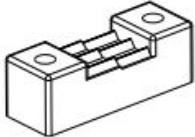
40	 <p>Filtro Hepsa e Filtro Nylon Função sono bom 5 anos de garantia Aviso limpar filtro</p> <p>Qualidade A Unidade interna</p> <p>Consul bem estar</p>	<p>EMBALAGEM PAPELÃO ONDULADO</p>
41		<p>CALCO EPS DIR</p>
42		<p>CALCO EPS ESQ</p>
43		<p>FILTRO AR HEPA</p>
44		<p>FILTRO DE AR DE CARBONO</p>
45		<p>EMBALAGEM SACO PLASTICO DO CONTROLE REMOTO</p>

46		GAXETA EMB DA TUBULACAO UNIT
47		TAMPA TRASEIRA
48		CAPA TRASEIRA DO EVAPORADOR
49		CLIQUE DO TERMISTOR
50		ABRACADEIRA DE PARAFUSO DA FIACAO
51		PRESILHA PLÁSTICA DA FIACAO-1221124

52		TAMPA DE PLASTICO DA CAIXA DE COMAND
53		CLIPE
54		SEPARADOR DE AGUA DO EVAPORADOR
55		EMBALAGEM SACO PLASTICO
56		REDE ELETRICA 1 VIA TERRA
57		BORNEIRA DA FIACAO
58		REDE ELETRICA BIVOLT

59		PRESILHA DO TERMISTOR - 1301100
60		BUCHA DO EIXO DO MOTOR - 1465593
61		PORCA 3/8
62		PORCA