

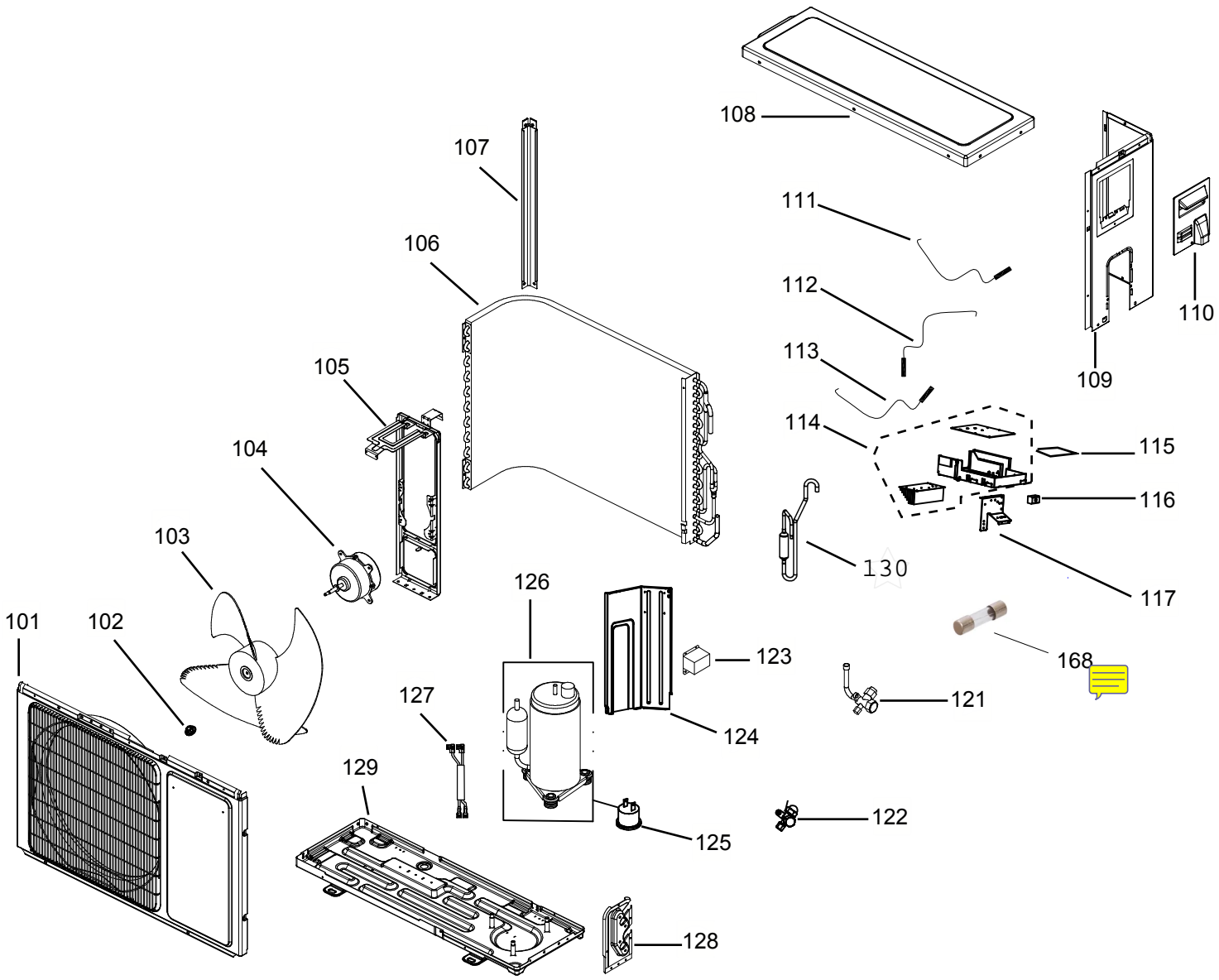







# CATÁLOGO DE PEÇAS

## CONDICIONADOR DE AR SPLIT CBG09CB

Revisão	Motivo	Páginas Alteradas	Elaborado Por	Data
00	Lançamento	Todas	Susy Dirani	9/10/12



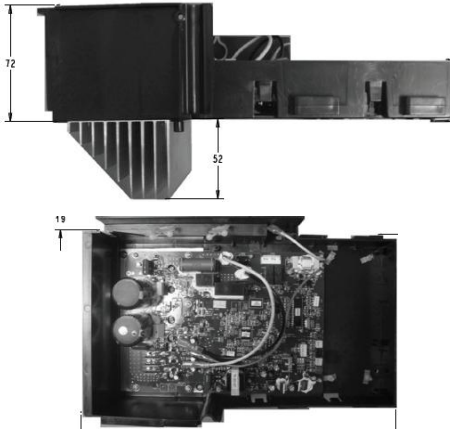
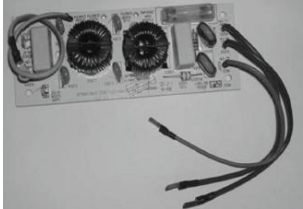

Informações complementares

Ref.	Código	Descrição/ Observação	Foto/ Referência
111	W10501891	Sensor de Temperatura Comprimento: 999mm	
112	W10501857	Sensor de Temperatura 1	
113	W10501856	Sensor de Temperatura 2	
114	W10502080	Módulo de Controle Inverter	
115	W10502102	Placa de Filtro	
121	W10501905	Válvula de Serviço	

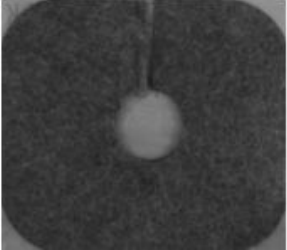

REF	IMAGEM/DESENHO	DESCRIÇÃO
139		TUBO DE DESCARGA Cj
140		PORCA COMPRESSOR-1226723
141		CLIQUE DO CONDENSADOR - 1335193
142		EMBALAGEM PAPELÃO ONDULADO
143		CALCO EPS INF
144		CALCO EPS SUP
145		EMBALAGEM PAPELÃO ONDULADO INF

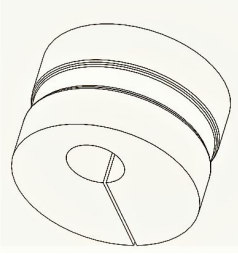
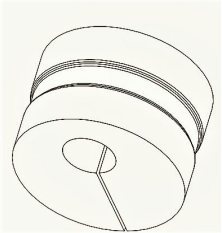
146		<p>EMBALAGEM SACO PLASTICO</p>
147		<p>MANTA DE ISOLACAO DO AR CONDICIONADO</p>
148		<p>ISOLACAO RUIDO</p>
149		<p>ISOLACAO RUIDO MANTA JUNTA DO COMPRESSOR</p>
150		<p>AMORTECEDOR DE VIBRACAO COND 24MM</p>
151		<p>AMORTECEDOR DE VIBRACAO COND 20MM</p>

152		CLIPE DO SENSOR DE TEMPERATURA
153		EMBLEMA CONSUL
154		ABRACADEIRA DO BULBO
155		AVISO DE CHOQUE ELETRICO
156		PORCA 1/4
157		PORCA 3/8
158		Diagrama Elétrico 9K

159		FIO CONEXÃO
160		REDE ELETRICA BIVOLT
162		FILTRO CAPILAR METALICO
163		TUBO CAPILAR CJ
164		FIO MARROM
165		ISOLACAO TERMICA DA TUBULACAO-1350025
166		TUBO DE SUCCAO

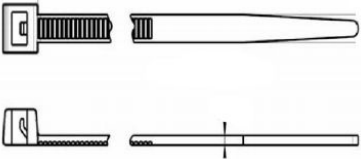

167		TUBO DE COBRE DO CONDICIONADOR 3/8
168		CINTA DE AMARRACAO