

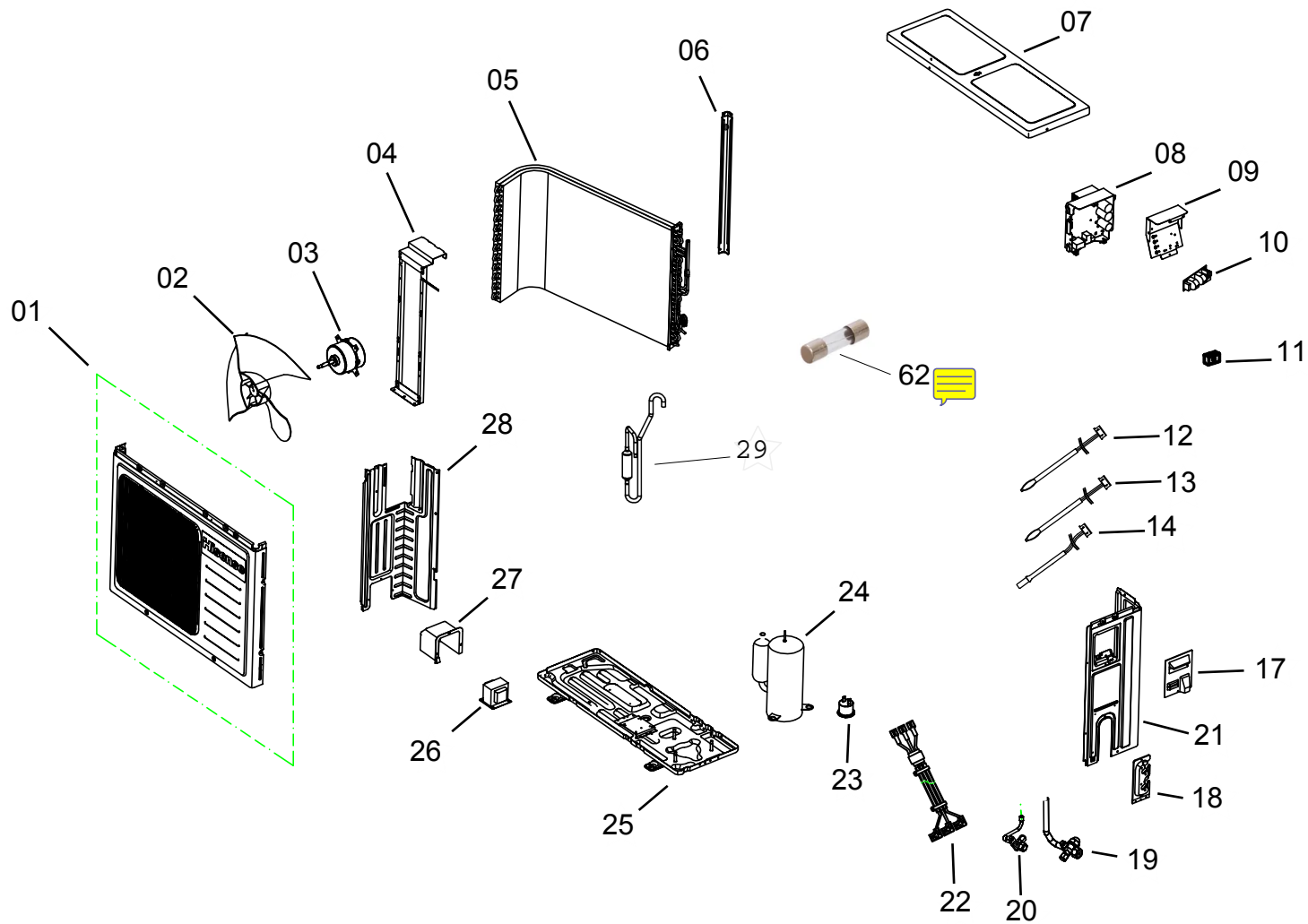

CATÁLOGO DE PEÇAS





CONDICIONADOR DE AR SPLIT CBG18CB





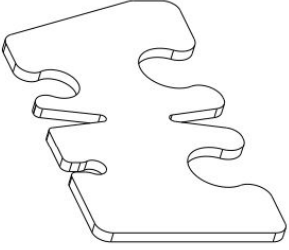
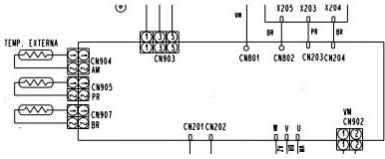

Revisão	Motivo	Páginas Alteradas	Elaborado Por	Data
00	Lançamento	Todas	Susy Dirani	5/12/12

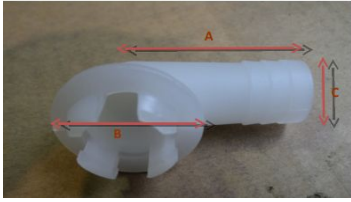

REF	IMAGEM/DESENHO	DESCRIÇÃO
30		<p>EMBALAGEM PAPELÃO ONDULADO</p>
31		<p>EMBALAGEM SACO PLÁSTICO - 1284713</p>
32		<p>CALÇO EPS SUPERIOR</p>
33		<p>CALÇO EPS INFERIOR</p>
34		<p>BASE PAPELÃO ONDULADO</p>
35		<p>PORCA DO AMORTECEDOR</p>
36		<p>ISOLACAO RUÍDO MATA JUNTA DO COMPRESSOR 1</p>
37		<p>ISOLACAO RUÍDO MATA JUNTA DO COMPRESSOR 2</p>

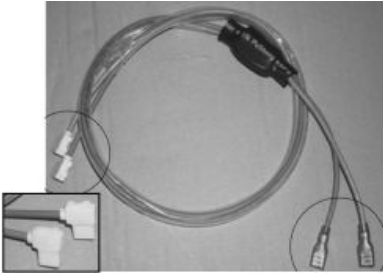
38		AMORTECEDOR DE VIBRACAO COND
39		SUPORTE DO REATOR
40		SUPORTE METÁLICO DO SENSOR - 8005362
41		CLIQUE DO SENSOR DE TEMPERATURA
42		EMBLEMA CONSUL
43		TUBO CAPILAR

44		ABRACADEIRA DO BULBO
45		DIAGRAMA ELETRICO
46		AVISO DE CHOQUE ELETRICO
47		PORCA COMPRESSOR-1226723
48		CLIQUE DO CONDENSADOR - 1335193
49		PORCA
50		PORCA 1/4

51		DRENO
52		TAMPA DE PLASTICO DOS TERMINAIS
53		FIO CONEXÃO 1
54		FIO CONEXÃO 2
55		REDE ELETRICA BIVOLT
56		ISOLACAO RUIDO MATA JUNTA DO COMPRESSOR

57		FILTRO CAPILAR METALICO
58		TUBO CAPILAR CJ
59		ISOLACAO TERMICA DA TUBULACAO-1350025
60		CINTA DE AMARRACAO
61		ABRACADEIRA DE PARAFUSO DA FIACAO