

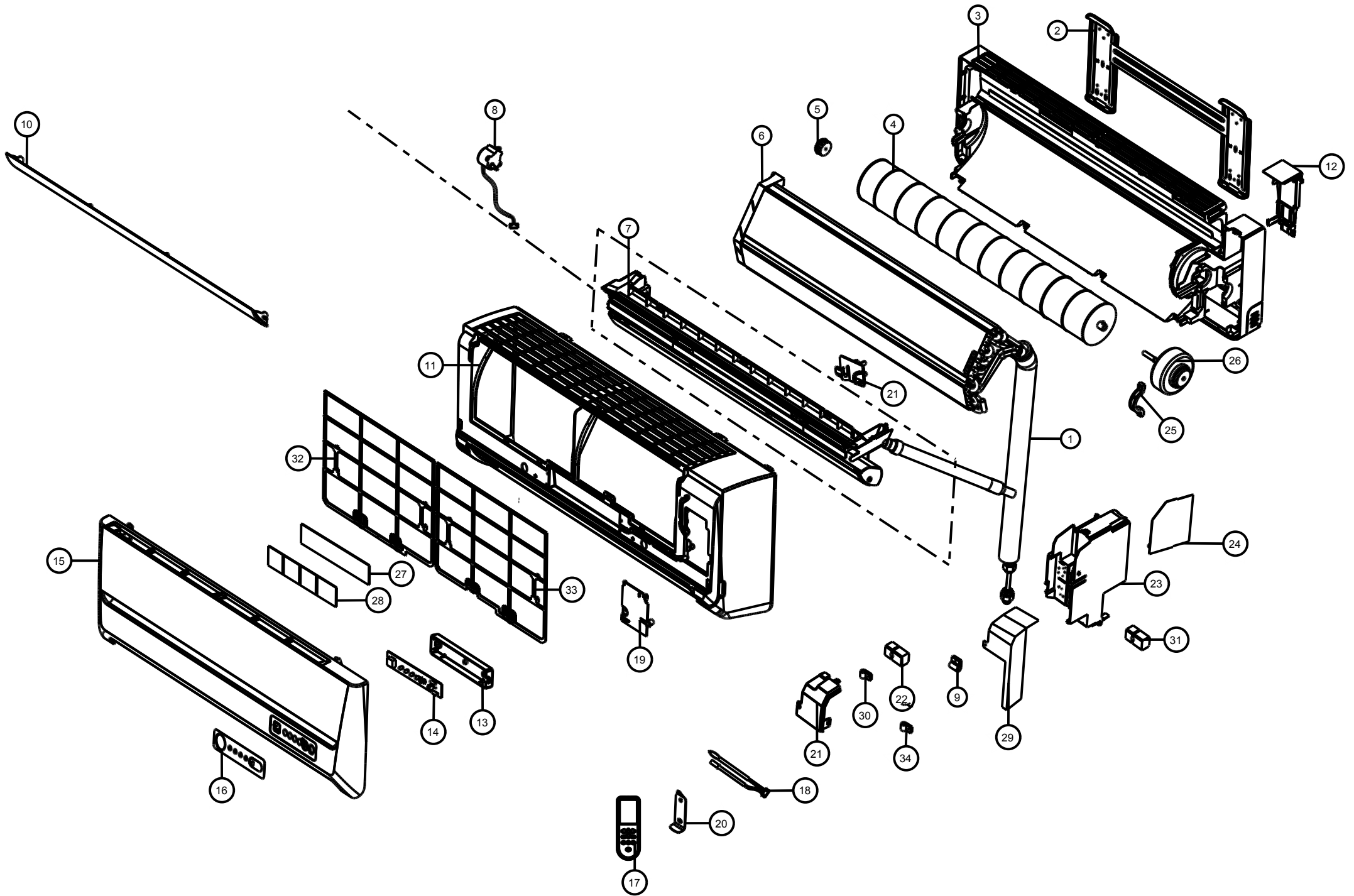





CATÁLOGO DE PEÇAS

CONDICIONADOR DE AR SPLIT

CBU12DBBNA

Revisão	Motivo	Páginas Alteradas	Elaborado Por	Revisado Por	Data
00	LANÇAMEN TO	TODAS	SUSY DIRANI	PROCESSOS TÉCNICO	1/10/12



REF	IMAGEM/DESENHO	DESCRIÇÃO
35		AVISO DE CHOQUE ELÉTRICO
36		MANUAL DE INSTRUÇÃO Kit
37		ISOLACAO TERMICA DA TUBULACAO
38		DEFLETOR DE AGUA
39		EMBALAGEM PAPELÃO ONDULADO
40		EMBALAGEM SACO PLÁSTICO
41		CAPA FRONTAL DO CONDICIONADOR BRANCA

42		PARAFUSO
43		CLIPE DO TERMISTOR
44		CAIXA DE COMANDO DE PLASTICO
45		TAMPA DE ACO DA CAIXA DE COMAND
46		SUPORTE DE INSTALACAO DO COND
47		CAIXA DE COMANDO DE METAL
48		TAMPA DE PLASTICO DA CAIXA DE COMAND

49		PRESILHA DO TERMISTOR - 1301100
50		ABRACADEIRA DE PARAFUSO DA FIACAO
51		FUSIVEL DE VIDRO 3,15 A
52		SELO PROCEL CONDICIONADOR DE AR
53		CORDAO DE ALIMENTACAO SEM PLUGUE BRANCO