

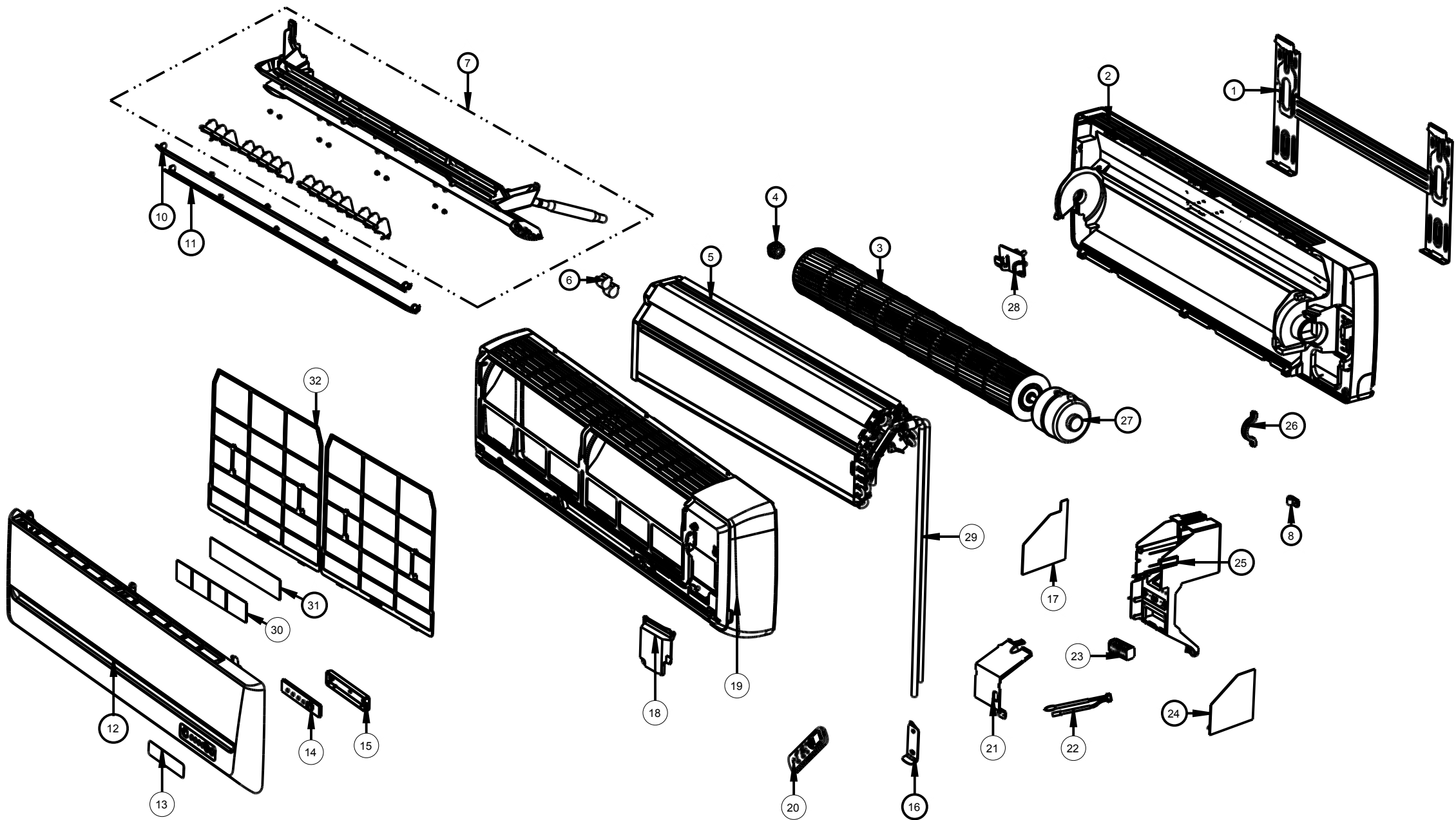





CATÁLOGO DE PEÇAS





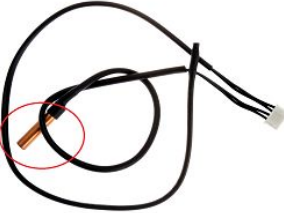

CONDICIONADOR DE AR SPLIT

CBV22CBBNA

Revisão	Motivo	Páginas Alteradas	Elaborado Por	Revisado Por	Data
00	LANÇAMEN TO	TODAS	SUSY DIRANI	PROCESSOS TÉCNICO	1/10/12



REF	IMAGEM/DESENHO	DESCRIÇÃO
33		CABO DE DEGELO - 1225804
34		REDE ELETRICA TERMISTOR
35		AVISO DE CHOQUE ELETRICO
36		MANUAL DE INSTRUCAO Kit
37		GAXETA EMB DA TUBULACAO UNIT
38		PAINEL DE CONTROLE BRANCO PAINEL DEC
39		CLIQUE DO TERMISTOR

40		CLIPE
41		EMBALAGEM PAPELÃO ONDULADO
42		EMBALAGEM SACO PLÁSTICO
43		CALCO EPS ESQ
44		CALCO EPS DIR
45		TAMPA DE AÇO DA CAIXA DE COMAND
46		CAIXA DE COMANDO DE METAL

47		Presilha da Fiação
48		PARAFUSO
49		EMBALAGEM SACO PLASTICO DO CONTROLE
50		TUBO DE SUCCAO
51		Tubo entrada unidade interna 3/8-1437308
52		CAPA TRASEIRA DO EVAPORADOR
53		PRESILHA DO TERMISTOR - 1301100

54		ESPACADOR DA BORNEIRA
55		FUSIVEL DE VIDRO 3,15 A
56		PORCA 3/8
57		PORCA 1/4