

CATÁLOGO DE PEÇAS

CONDICIONADOR DE AR SPLIT

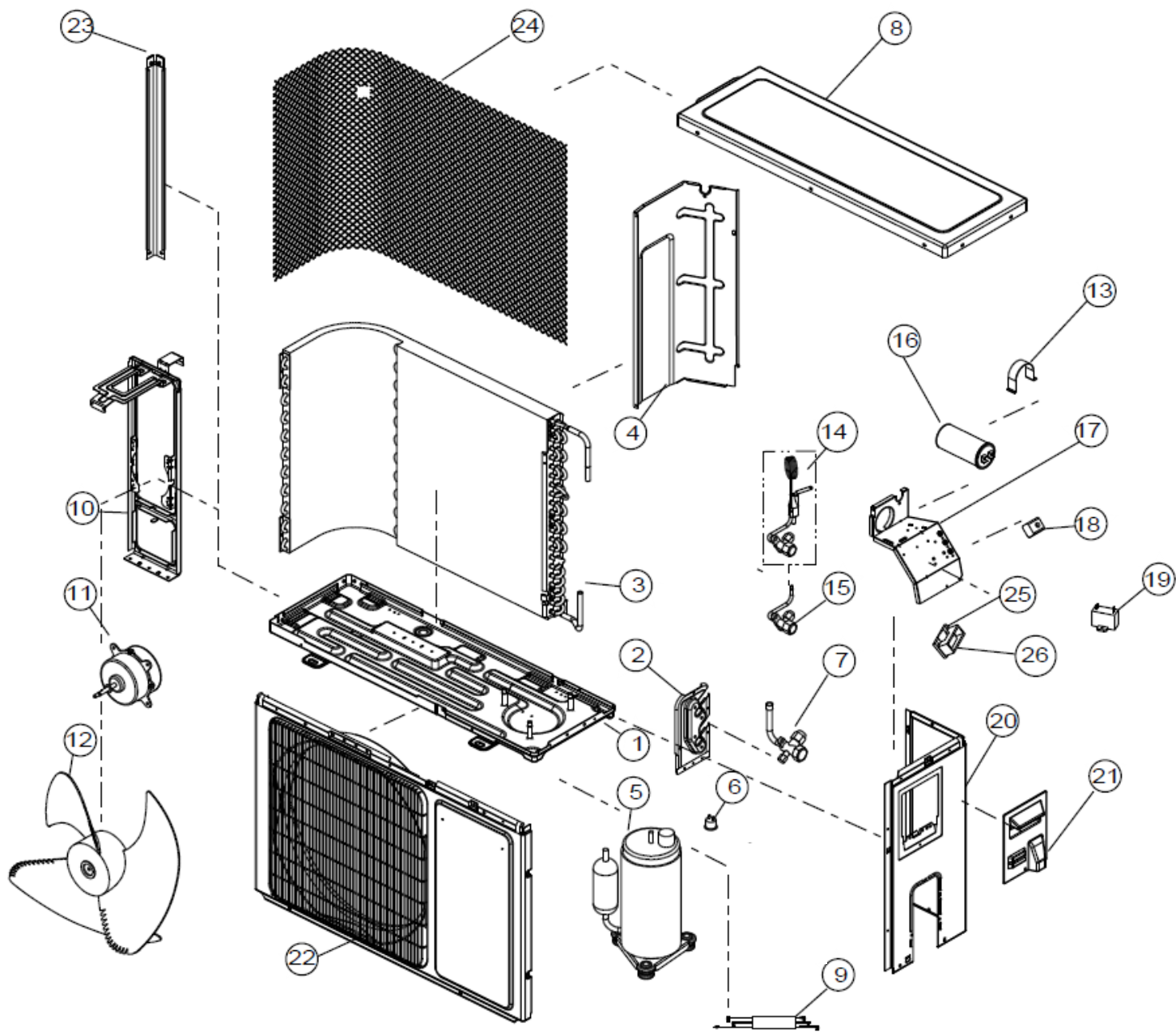





CBY07DBBNA

Revisão	Motivo	Páginas Alteradas	Elaborado Por	Revisado Por	Data
00	LANÇAMEN TO	TODAS	SUSY DIRANI	PROCESSOS TÉCNICO	1/10/12

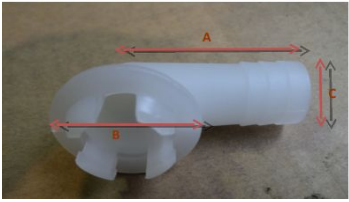

REF	IMAGEM/DESENHO	DESCRIÇÃO
26		TUBO DESCARGA
27		ARRUELA DE VEDACAO BORRACHA
28		TAMPA PLASTICO TERMINAIS
29		GAXETA EMB DA TAMPA TERMINAIS PRETO UNIT
30		PORCA DA TAMPA DO COMPRESSOR
31		PORCA COMPRESSOR-1226723

32		MOLA DA PROTECAO TERMICA
33		AMORTECEDOR DO COMPRESSOR
34		AMORTECEDOR DE VIBRACAO COND 20 MM
35		AMORTECEDOR DE VIBRACAO COND 20 MM
36		TUBO DE SUCCAO
37		EMBALAGEM PAPELAO ONDULADO
38		CALCO EPS INF

39		CALCO EPS SUP
40		EMBALAGEM SACO PLASTICO
41		AVISO DE CHOQUE ELETRICO
42		EMBLEMA CONSUL
43		DRENO - 1227300
44		PORCA DO VENTILADOR - 1226721

45		CAPACITOR 15UF 450VAC SIMPLES
46		TUBO CAPILAR
47		ISOLACAO TERMICA DA TUBULACAO-1350025
48		CINTA DE AMARRACAO
49		MOTOR DO VENTILADOR 220V
50		ABRACADEIRA DE PARAFUSO DA FIACAO

51		PORCA 1/4
52		PORCA 3/8