

# CATÁLOGO DE PEÇAS

## CONDICIONADOR DE AR SPLIT

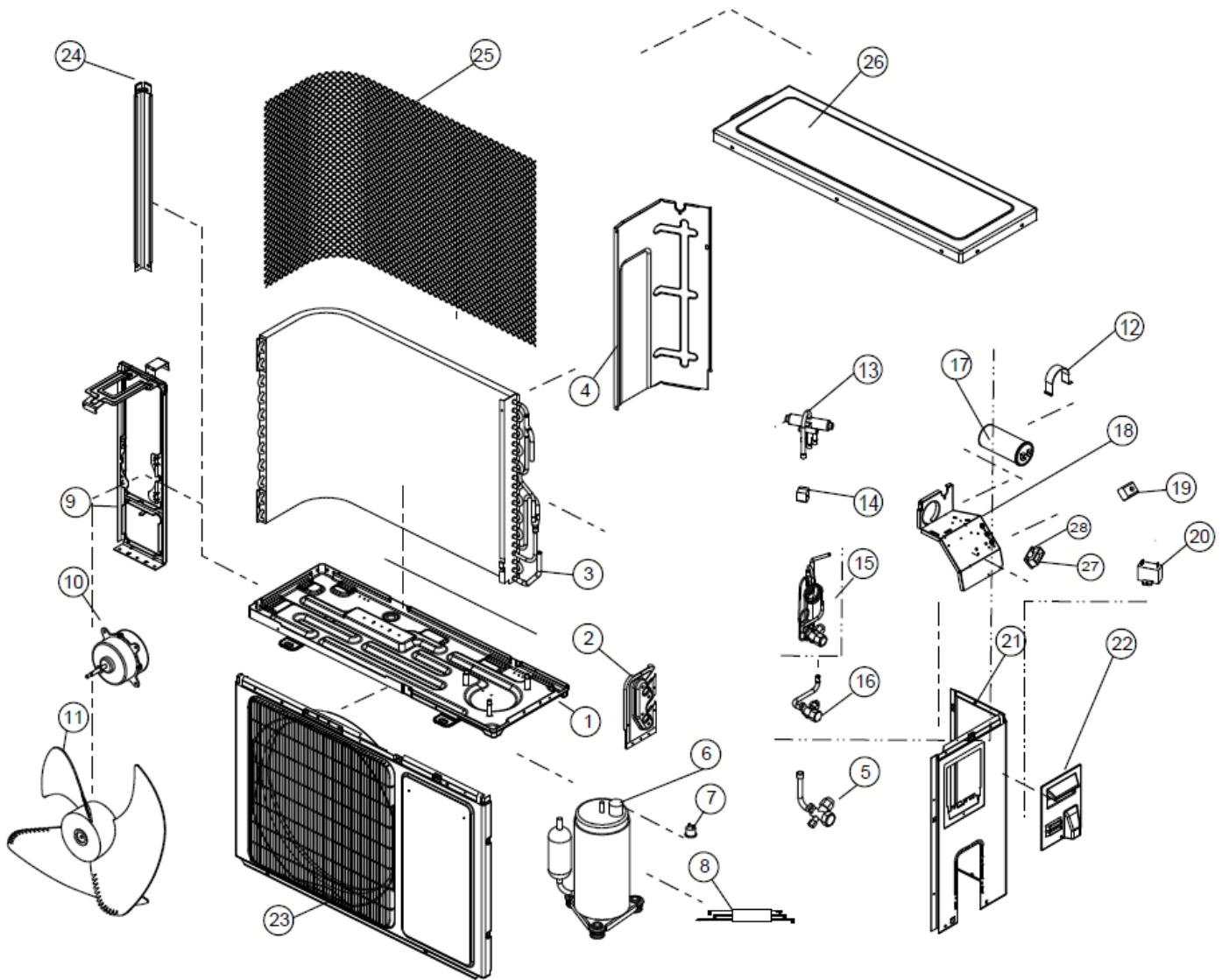



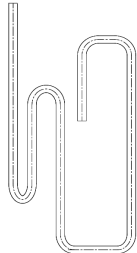
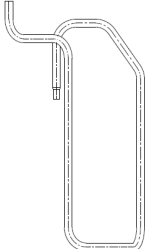
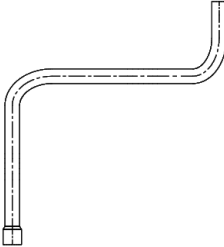
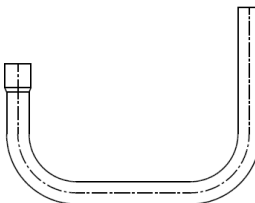

CBZ07CBBNA

Revisão	Motivo	Páginas Alteradas	Elaborado Por	Revisado Por	Data
00	LANÇAMENTO	TODAS	SUSY DIRANI	PROCESSOS TÉCNICO	6/03/13
10	Linhas de sucção e descarga	3	83528	EPI	10/1/17

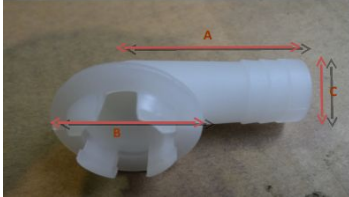

INFORMAÇÕES COMPLEMENTARES			
REF	CÓDIGO	DESCRIÇÃO/ OBSERVAÇÃO	IMAGEM/DESENHO
30	W10178677	LINHA DE SUCCÃO	
31	W10396853	LINHA DE DESCARGA	
32	W10178666	COMPLEMENTO LINHA DE SUCCÃO	
33	W10396108	COMPLEMENTO LINHA DE DESCARGA	

REF	IMAGEM/DESENHO	DESCRIÇÃO
34		AMORTECEDOR DE VIBRACAO COND 1
35		AMORTECEDOR DE VIBRACAO COND 29 MM
36		AMORTECEDOR DE VIBRACAO COND 30 MM
37		AMORTECEDOR DO COMPRESSOR
38		ARRUELA DE VEDACAO BORRACHA
39		AVISO DE CHOQUE ELETRICO

40		CALCO EPS INF
41		CALCO EPS SUP
42		DRENO
43		EMBALAGEM PAPELÃO ONDULADO SUP
44		EMBALAGEM SACO PLASTICO
45		EMBLEMA CONSUL
46		GAXETA EMB DA TAMPA TERMINAIS PRETO UNIT

47		MOLA DA PROTECAO TERMICA
48		PORCA COMPRESSOR-1226723
49		PORCA DA TAMPA DO COMPRESSOR
50		PROTETOR TERMICO BIVOLT
51		TAMPA PLASTICO TERMINAIS