

Vista Explodida do Produto

Motivo	Lançamento
Modelo do produto	GMT40AB
Categoria do produto	Micro-Ondas
Marcas do produto	Brastemp
Foto peça	Itens com foto aparecerá o símbolo amarelo 

**Em caso de dúvida,
entre em contato com
o CDP CÓDIGO:
VIA ATIVIDADE CRM
OU
ATIVIDADE CONEXÃO
SERVIÇOS**

OBS: Para abrir a foto, clique duas vezes no desenho da peça.



Consul



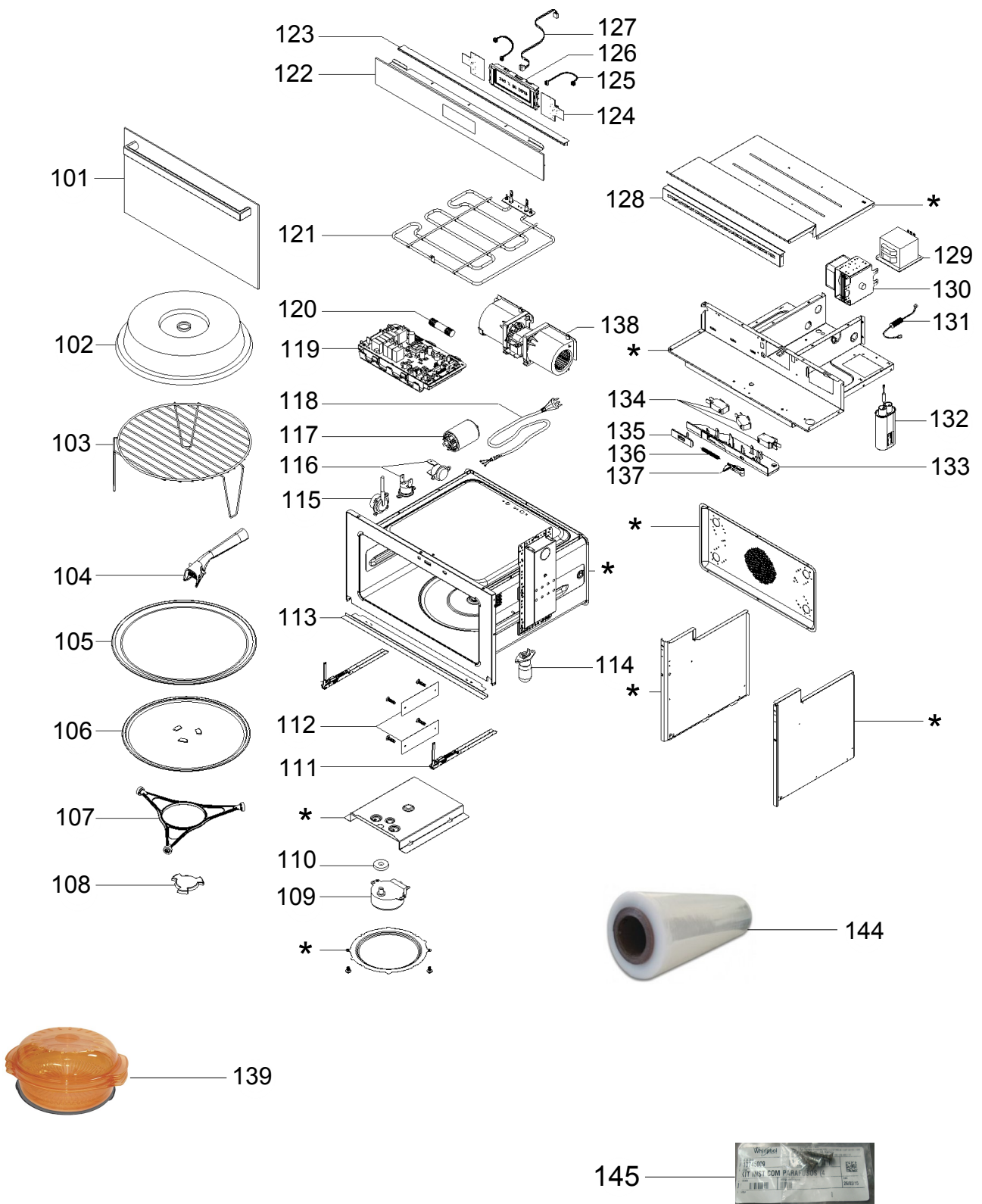

KitchenAid

ASSISTÊNCIA
TÉCNICA
AUTORIZADA

Todos os direitos reservados:
Whirlpool Latin America

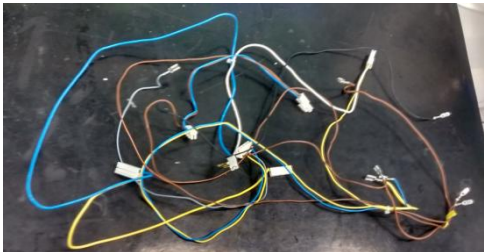

Itens com asterisco (*) não são itens de reposição

Foto	Código	Descrição	Referência
	W10840530	CHICOTE PLANO (481068967651)	125
	W10840525	MOLA TRAVA (481010507067)	136
	W10840527	CHAVE ALAVANCA. (481010506969)	137
	326070737	Suporte do Fusível (481925638016)	140
	W10767765	CABO CHICOTE (4810 105 27345)	141

	W10732283	SENSOR TEMPERATURA (4810 105 88516)	142
	W10767766	CABO MOTOR PRATO (4810 105 27349)	143